

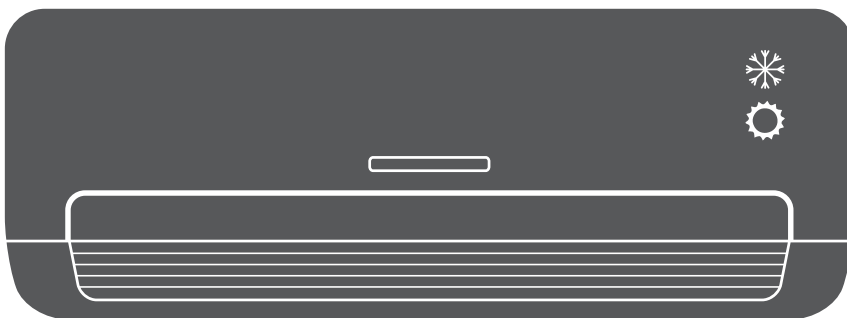

AIR CONDITIONING SYSTEMS

WALL MOUNTED UNIT

- **USER'S MANUAL**
- **ΕΓΧΕΙΡΙΔΙΟ ΧΡΗΣΗΣ**
- **MANUAL UTILIZATORULUI**



MODELS:

O3MVI32-09WiFiR / O3MVO32-09
O3MVI32-12WiFiR / O3MVO32-12
O3MVI32-18WiFiR / O3MVO32-18
O3MVI32-24WiFiR / O3MVO32-24



Table of Contents

Owner's Manual

0 Safety Precautions.....04

1 Unit Specifications and Features.....06



3	Care and Maintenance	12
4	Troubleshooting	14
5	European Disposal Guidelines	18

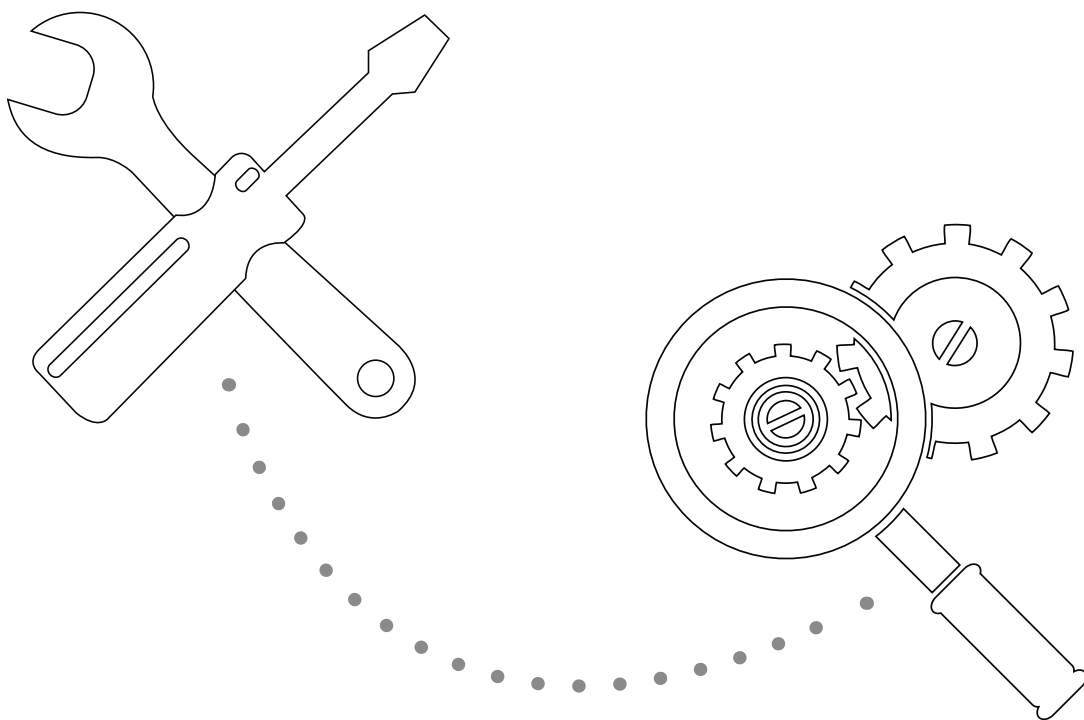

**Caution: Risk of fire/
flammable materials**

WARNING: Servicing shall only be performed as recommended by the equipment manufacturer. Maintenance and repair requiring the assistance of other skilled personnel shall be carried out under the supervision of the person competent in the use of flammable refrigerants. For more details, please refer to the Information on servicing on INSTALLATION MANUAL.

Safety Precautions

Read Safety Precautions Before Installation

Incorrect installation due to ignoring instructions can cause serious damage or injury.

The seriousness of potential damage or injuries is classified as either a **WARNING** or **CAUTION**.



WARNING

This symbol indicates that ignoring instructions may cause death or serious injury.



CAUTION

This symbol indicates that ignoring instructions may cause moderate injury to your person, or damage to your appliance or other property.



WARNING

This appliance can be used by children aged from 8 years and above and persons with reduced physical, sensory or mental capabilities or lack of experience and knowledge if they have been given supervision or instruction concerning use of the appliance in a safe way and understand the hazards involved. Children shall not play with the appliance. Cleaning and user maintenance shall not be made by children without supervision.

INSTALLATION WARNINGS

- Ask an authorized dealer to install this air conditioner. Inappropriate installation may cause water leakage, electric shock, or fire.
- All repairs, maintenance and relocation of this unit must be performed by an authorized service technician. Inappropriate repairs can lead to serious injury or product failure.

WARNINGS FOR PRODUCT USE

- If an abnormal situation arises (like a burning smell), immediately turn off the unit and pull the power plug. Call your dealer for instructions to avoid electric shock, fire or injury.
- **Do not** insert fingers, rods or other objects into the air inlet or outlet. This may cause injury, since the fan may be rotating at high speeds.
- **Do not** use flammable sprays such as hair spray, lacquer or paint near the unit. This may cause fire or combustion.
- **Do not** operate the air conditioner in places near or around combustible gases. Emitted gas may collect around the unit and cause explosion.
- **Do not** operate the air conditioner in a wet room (e.g., bathroom or laundry room). This can cause electrical shock and cause the product to deteriorate.
- **Do not** expose your body directly to cool air for a prolonged period of time.

ELECTRICAL WARNINGS

- Only use the specified power cord. If the power cord is damaged, it must be replaced by the manufacturer or certified service agent.
- Keep power plug clean. Remove any dust or grime that accumulates on or around the plug. Dirty plugs can cause fire or electric shock.
- **Do not** pull power cord to unplug unit. Hold the plug firmly and pull it from the outlet. Pulling directly on the cord can damage it, which can lead to fire or electric shock.
- **Do not** use an extension cord, manually extend the power cord, or connect other appliances to the same outlet as the air conditioner. Poor electrical connections, poor insulation, and insufficient voltage can cause fire.





CLEANING AND MAINTENANCE WARNINGS

- Turn off the device and pull the plug before cleaning. Failure to do so can cause electrical shock.
- **Do not** clean the air conditioner with excessive amounts of water.
- **Do not** clean the air conditioner with combustible cleaning agents. Combustible cleaning agents can cause fire or deformation.

CAUTION

- If the air conditioner is used together with burners or other heating devices, thoroughly ventilate the room to avoid oxygen deficiency.
- Turn off the air conditioner and unplug the unit if you are not going to use it for a long time.
- Turn off and unplug the unit during storms.
- Make sure that water condensation can drain unhindered from the unit.
- **Do not** operate the air conditioner with wet hands. This may cause electric shock.
- **Do not** use device for any other purpose than its intended use.
- **Do not** climb onto or place objects on top of the outdoor unit.
- **Do not** allow the air conditioner to operate for long periods of time with doors or windows open, or if the humidity is very high.

Explanation of symbols displayed on the indoor unit or outdoor unit:

	WARNING	This symbol shows that this appliance used a flammable refrigerant. If the refrigerant is leaked and exposed to an external ignition source, there is a risk of fire.
	CAUTION	This symbol shows that the operation manual should be read carefully.
	CAUTION	This symbol shows that a service personnel should be handling this equipment with reference to the installation manual.
	CAUTION	
	CAUTION	This symbol shows that information is available such as the operating manual or installation manual.

Unit Specifications and Features

1

Unit Parts

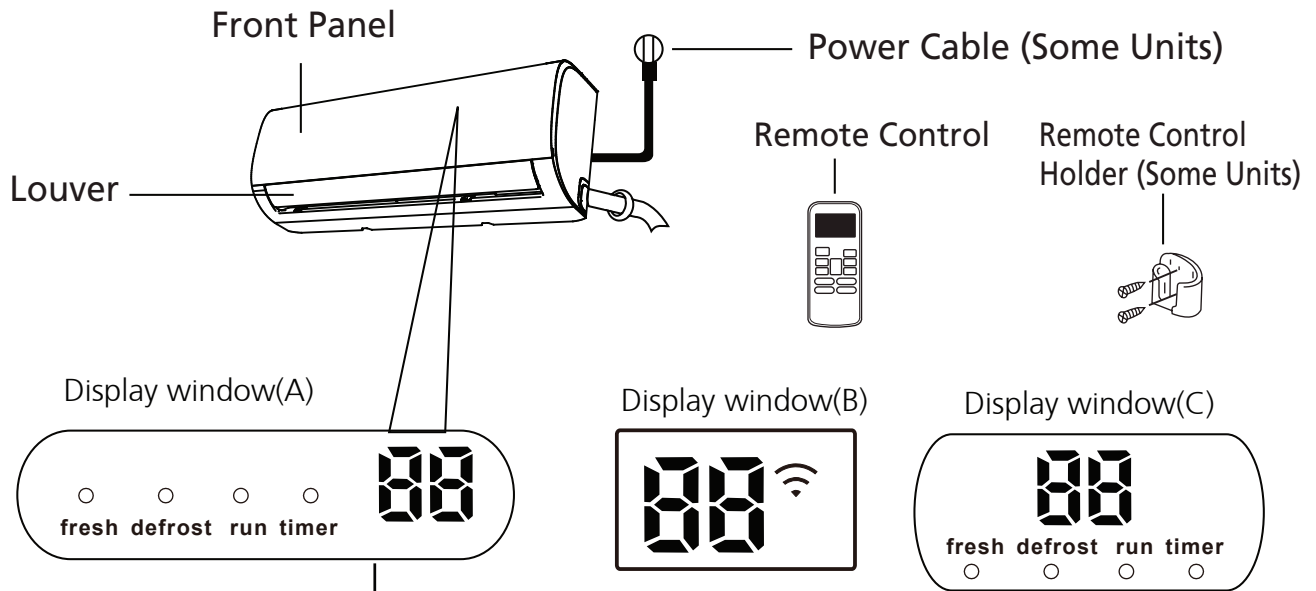

"fresh" when Fresh feature is activated

"defrost" when defrost feature is activated.

"run" when the unit is on.

"timer" when TIMER is set.

"88" Not available for all units.

When ECO function is activated, the

'88' illuminates gradually one by one as --E

E--0 --set temperature -- E in one second interval.

In other modes, the unit will display your temperature setting.

In Fan mode, the unit will display the room temperature.

When error occurs, it displays error code.

"00" for 3 seconds when:

- TIMER ON is set
- FRESH, SWING, TURBO, or SILENCE features are turned on

"0F" for 3 seconds when:

- TIMER OFF is set
- FRESH, SWING, TURBO, or SILENCE features are turned off

"cF" when anti-cold air feature is turned on

"dF" when defrosting

"Sc" when unit is self-cleaning

"FP" when freeze protection is turned on

"Wi" when Wireless Control feature is activated (some units)

Display Code Meanings

NOTE: A guide on using the infrared remote is not included in this literature package.

Achieving Optimal Performance

Optimal performance for the COOL, HEAT, and DRY modes can be achieved in the following temperature ranges. When your air conditioner is used outside of these ranges, certain safety protection features will activate and cause the unit to perform less than optimally.

Inverter Split Type

	COOL mode	HEAT mode	DRY mode
Room Temperature	17°C - 32°C (63°F - 90°F)	0°C - 30°C (32°F - 86°F)	10°C - 32°C (50°F - 90°F)
Outdoor Temperature	0°C - 50°C (32°F - 122°F)	-15°C - 30°C (5°F - 86°F)	0°C - 50°C (32°F - 122°F)
	-15°C - 50°C (5°F - 122°F) (For models with low temp. cooling systems.)		
	0°C - 60°C (32°F - 140°F) (For special tropical models)		0°C - 60°C (32°F - 140°F) (For special tropical models)

FOR OUTDOOR UNITS WITH AUXILIARY ELECTRIC HEATER

When outside temperature is below 0°C (32°F), we strongly recommend keeping the unit plugged in at all time to ensure smooth ongoing performance.

Fixed-speed Type

	COOL mode	HEAT mode	DRY mode
Room Temperature	17°-32°C (63°-90°F)	0°-30°C (32°-86°F)	10°-32°C (50°-90°F)
Outdoor Temperature	18°-43°C (64°-109°F)	-7°-24°C (19°-75°F)	11°-43°C (52°-109°F)
	-7°-43°C (19°-109°F) (For models with low-temp cooling systems)		18°-43°C (64°-109°F)
	18°-54°C (64°-129°F) (For special tropical models)		18°-54°C (64°-129°F) (For special tropical models)

To further optimize the performance of your unit, do the following:

- Keep doors and windows closed.
- Limit energy usage by using TIMER ON and TIMER OFF functions.
- Do not block air inlets or outlets.
- Regularly inspect and clean air filters.

For a detailed explanation of each function, refer to the **Remote Control Manual**.

Other Features

- **Auto-Restart**

If the unit loses power, it will automatically restart with the prior settings once power has been restored.

- **Anti-mildew**

When turning off the unit from COOL, AUTO (COOL), or DRY modes, the air conditioner will continue operate at very low power to dry up condensed water and prevent mildew growth.

- **Refrigerant Leakage Detection**

The indoor unit will automatically display "EC" when the unit detects refrigerant leakage.

- **Wireless Control**

Wireless control allows you to control your air conditioner using your mobile phone and a Wireless connection.

For the USB device access, replacement, maintenance operations must be carried out by professional staff.

- **Louver Angle Memory**

When turning on your unit, the louver will automatically resume its former angle.

For a detailed explanation of your unit's advanced functionality (such as TURBO mode and its self-cleaning functions), refer to the **Remote Control Manual**.

NOTE ON ILLUSTRATIONS

Illustrations in this manual are for explanatory purposes. The actual shape of your indoor unit may be slightly different. The actual shape shall prevail.

• Setting Angle of Air Flow

Setting horizontal angle of air flow

The horizontal angle of the airflow must be set manually. Grip the deflector rod (See **Fig.B**) and manually adjust it to your preferred direction.

For some units, the horizontal angle of the airflow can be set by remote control. please refer to the Remote Control Manual.

NOTE ON LOUVER ANGLES

When using COOL or DRY mode, do not set louver at too vertical an angle for long periods of time. This can cause water to condense on the louver blade, which will drop on your floor or furnishings. (See **Fig.A**)

When using COOL or HEAT mode, setting the louver at too vertical an angle can reduce the performance of the unit due to restricted air flow.

Do not move louver by hand. This will cause the louver to become out of sync. If this occurs, turn off the unit and unplug it for a few seconds, then restart the unit. This will reset the louver.

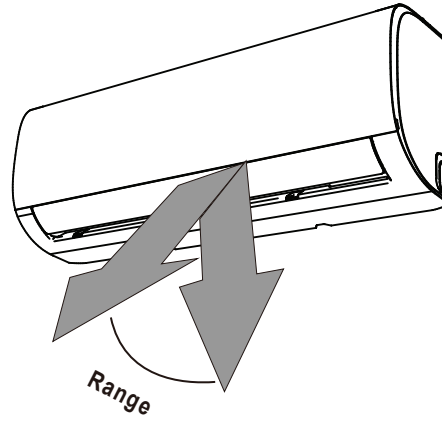

! Caution: Do not keep louver at too vertical an angle for long periods of time. This can cause water condensation to drip on your furnishings.

Fig. A

! CAUTION

Do not put your fingers in or near the blower and suction side of the unit. The high-speed fan inside the unit may cause injury.

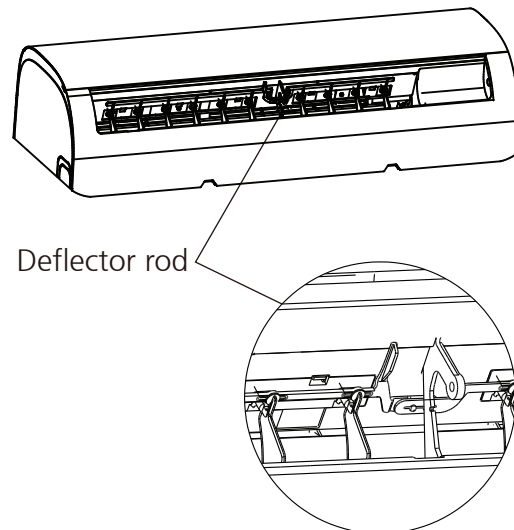

Fig. B

- **Sleep Operation**

The SLEEP function is used to decrease energy use while you sleep (and don't need the same temperature settings to stay comfortable). This function can only be activated via remote control.

Press the **SLEEP** button when you are ready to go to sleep. When in COOL mode, the unit will increase the temperature by 1°C (2°F) after 1 hour, and will increase an additional 1°C (2°F) after another hour. When in HEAT mode, the unit will decrease the temperature by 1°C (2°F) after 1 hour, and will decrease an additional 1°C (2°F) after another hour.

It will hold the new temperature for 5 hours, then the unit will turn off automatically.

Note: The SLEEP function is not available in FAN or DRY mode.

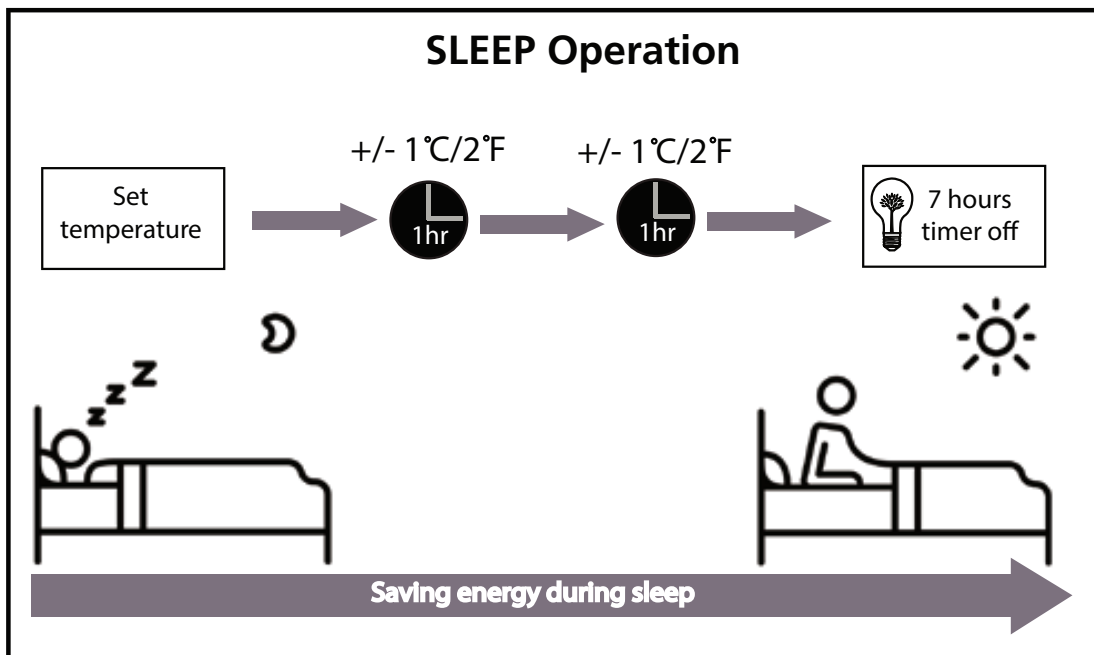

Manual Operation (Without Remote)

2

How to operate your unit without the remote control

In the event that your remote control fails to work, your unit can be operated manually with the **MANUAL CONTROL** button located on the indoor unit. Note that manual operation is not a long-term solution, and that operating the unit with your remote control is strongly recommended.

BEFORE MANUAL OPERATION

Unit must be turned off before manual operation.

To operate your unit manually:

1. Open the front panel of the indoor unit.
2. Locate the **MANUAL CONTROL button** on the right-hand side of the unit.
3. Press the **MANUAL CONTROL button** one time to activate FORCED AUTO mode.
4. Press the **MANUAL CONTROL button** again to activate FORCED COOLING mode.
5. Press the **MANUAL CONTROL button** a third time to turn the unit off.
6. Close the front panel.

! CAUTION

The manual button is intended for testing purposes and emergency operation only. Please do not use this function unless the remote control is lost and it is absolutely necessary. To restore regular operation, use the remote control to activate the unit.

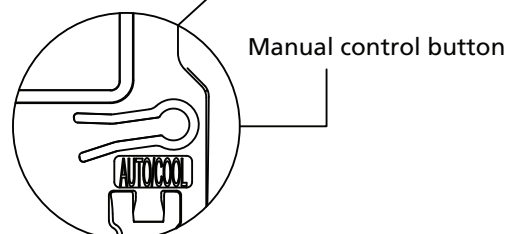
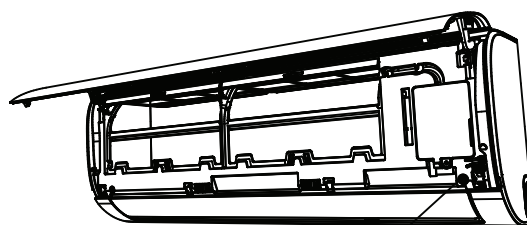

Care and Maintenance

3

Cleaning Your Indoor Unit



BEFORE CLEANING OR MAINTENANCE

ALWAYS TURN OFF YOUR AIR CONDITIONER SYSTEM AND DISCONNECT ITS POWER SUPPLY BEFORE CLEANING OR MAINTENANCE.



CAUTION

Only use a soft, dry cloth to wipe the unit clean. If the unit is especially dirty, you can use a cloth soaked in warm water to wipe it clean.

- **Do not** use chemicals or chemically treated cloths to clean the unit
- **Do not** use benzene, paint thinner, polishing powder or other solvents to clean the unit. They can cause the plastic surface to crack or deform.
- **Do not** use water hotter than 40°C (104°F) to clean the front panel. This can cause the panel to deform or become discolored.

Cleaning Your Air Filter

A clogged air conditioner can reduce the cooling efficiency of your unit, and can also be bad for your health. Make sure to clean the filter once every two weeks.

1. Lift the front panel of the indoor unit.
2. First press the tab on the end of filter to loosen the buckle, lift it up, then pull it towards yourself.
3. Now pull the filter out.
4. If your filter has a small air freshening filter, unclip it from the larger filter. Clean this air freshening filter with a hand-held vacuum.
5. Clean the large air filter with warm, soapy water. Be sure to use a mild detergent.

6. Rinse the filter with fresh water, then shake off excess water.
7. Dry it in a cool, dry place, and refrain from exposing it to direct sunlight.
8. When dry, re-clip the air freshening filter to the larger filter, then slide it back into the indoor unit.
9. Close the front panel of the indoor unit.

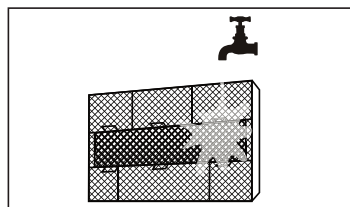
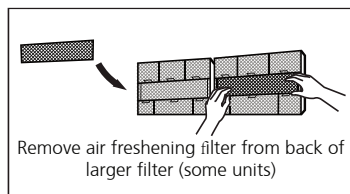
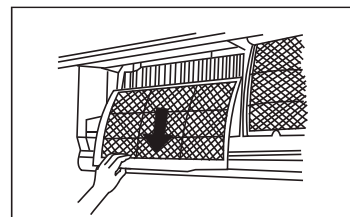
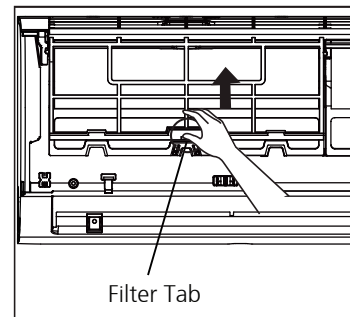

CAUTION

Do not touch air freshening (Plasma) filter for at least 10 minutes after turning off the unit.

! CAUTION

- Before changing the filter or cleaning, turn off the unit and disconnect its power supply.
- When removing filter, do not touch metal parts in the unit. The sharp metal edges can cut you.
- Do not use water to clean the inside of the indoor unit. This can destroy insulation and cause electrical shock.
- Do not expose filter to direct sunlight when drying. This can shrink the filter.

! CAUTION

- Any maintenance and cleaning of outdoor unit should be performed by an authorized dealer or a licensed service provider.
- Any unit repairs should be performed by an authorized dealer or a licensed service provider.

Maintenance – Long Periods of Non-Use

If you plan not to use your air conditioner for an extended period of time, do the following:

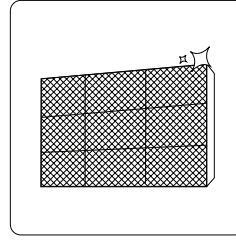

Clean all filters

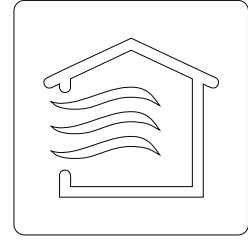

Turn on FAN function until unit dries out completely

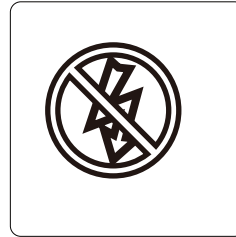

Turn off the unit and disconnect the power

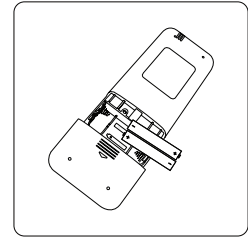

Remove batteries from remote control

Maintenance – Pre-Season Inspection

After long periods of non-use, or before periods of frequent use, do the following:

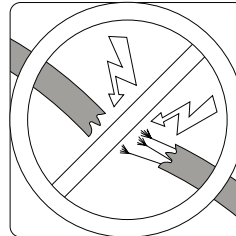

Check for damaged wires

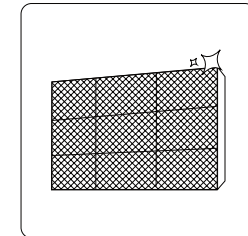

Clean all filters



Check for leaks

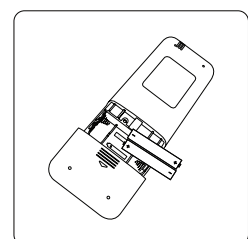

Replace batteries

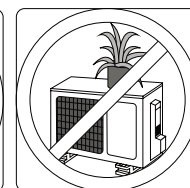
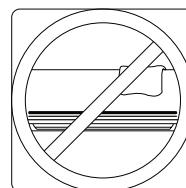

Make sure nothing is blocking all air inlets and outlets

Troubleshooting

4

SAFETY PRECAUTIONS

If ANY of the following conditions occurs, turn off your unit immediately!

- The power cord is damaged or abnormally warm
- You smell a burning odor
- The unit emits loud or abnormal sounds
- A power fuse blows or the circuit breaker frequently trips
- Water or other objects fall into or out of the unit

DO NOT ATTEMPT TO FIX THESE YOURSELF! CONTACT AN AUTHORIZED SERVICE PROVIDER IMMEDIATELY!

Common Issues

The following problems are not a malfunction and in most situations will not require repairs.

Issue	Possible Causes
Unit does not turn on when pressing ON/OFF button	The Unit has a 3-minute protection feature that prevents the unit from overloading. The unit cannot be restarted within three minutes of being turned off.
The unit changes from COOL/HEAT mode to FAN mode	The unit may change its setting to prevent frost from forming on the unit. Once the temperature increases, the unit will start operating in the previously selected mode again.
	The set temperature has been reached, at which point the unit turns off the compressor. The unit will continue operating when the temperature fluctuates again.
The indoor unit emits white mist	In humid regions, a large temperature difference between the room's air and the conditioned air can cause white mist.
Both the indoor and outdoor units emit white mist	When the unit restarts in HEAT mode after defrosting, white mist may be emitted due to moisture generated from the defrosting process.

Issue	Possible Causes
The indoor unit makes noises	A rushing air sound may occur when the louver resets its position.
	A squeaking sound may occur after running the unit in HEAT mode due to expansion and contraction of the unit's plastic parts.
Both the indoor unit and outdoor unit make noises	Low hissing sound during operation: This is normal and is caused by refrigerant gas flowing through both indoor and outdoor units.
	Low hissing sound when the system starts, has just stopped running, or is defrosting: This noise is normal and is caused by the refrigerant gas stopping or changing direction.
	Squeaking sound: Normal expansion and contraction of plastic and metal parts caused by temperature changes during operation can cause squeaking noises.
The outdoor unit makes noises	The unit will make different sounds based on its current operating mode.
Dust is emitted from either the indoor or outdoor unit	The unit may accumulate dust during extended periods of non-use, which will be emitted when the unit is turned on. This can be mitigated by covering the unit during long periods of inactivity.
The unit emits a bad odor	The unit may absorb odors from the environment (such as furniture, cooking, cigarettes, etc.) which will be emitted during operations.
	The unit's filters have become moldy and should be cleaned.
The fan of the outdoor unit does not operate	During operation, the fan speed is controlled to optimize product operation.
Operation is erratic, unpredictable, or unit is unresponsive	<p>Interference from cell phone towers and remote boosters may cause the unit to malfunction.</p> <p>In this case, try the following:</p> <ul style="list-style-type: none"> • Disconnect the power, then reconnect. • Press ON/OFF button on remote control to restart operation.

NOTE: If problem persists, contact a local dealer or your nearest customer service center. Provide them with a detailed description of the unit malfunction as well as your model number.

Troubleshooting

When troubles occur, please check the following points before contacting a repair company.

Problem	Possible Causes	Solution
Poor Cooling Performance	Temperature setting may be higher than ambient room temperature	Lower the temperature setting
	The heat exchanger on the indoor or outdoor unit is dirty	Clean the affected heat exchanger
	The air filter is dirty	Remove the filter and clean it according to instructions
	The air inlet or outlet of either unit is blocked	Turn the unit off, remove the obstruction and turn it back on
	Doors and windows are open	Make sure that all doors and windows are closed while operating the unit
	Excessive heat is generated by sunlight	Close windows and curtains during periods of high heat or bright sunshine
	Too many sources of heat in the room (people, computers, electronics, etc.)	Reduce amount of heat sources
	Low refrigerant due to leak or long-term use	Check for leaks, re-seal if necessary and top off refrigerant
SILENCE function is activated(optional function)	SILENCE function can lower product performance by reducing operating frequency. Turn off SILENCE function.	

Problem	Possible Causes	Solution
The unit is not working	Power failure	Wait for the power to be restored
	The power is turned off	Turn on the power
	The fuse is burned out	Replace the fuse
	Remote control batteries are dead	Replace batteries
	The Unit's 3-minute protection has been activated	Wait three minutes after restarting the unit
	Timer is activated	Turn timer off
The unit starts and stops frequently	There's too much or too little refrigerant in the system	Check for leaks and recharge the system with refrigerant.
	Incompressible gas or moisture has entered the system.	Evacuate and recharge the system with refrigerant
	The compressor is broken	Replace the compressor
	The voltage is too high or too low	Install a manostat to regulate the voltage
Poor heating performance	The outdoor temperature is extremely low	Use auxiliary heating device
	Cold air is entering through doors and windows	Make sure that all doors and windows are closed during use
	Low refrigerant due to leak or long-term use	Check for leaks, re-seal if necessary and top off refrigerant
Indicator lamps continue flashing	<p>The unit may stop operation or continue to run safely. If the indicator lamps continue to flash or error codes appear, wait for about 10 minutes. The problem may resolve itself. If not, disconnect the power, then connect it again. Turn the unit on.</p> <p>If the problem persists, disconnect the power and contact your nearest customer service center.</p>	
Error code appears in the window display of indoor unit: <ul style="list-style-type: none"> • E0, E1, E2... • P1, P2, P3... • F1, F2, F3... 		

NOTE: If your problem persists after performing the checks and diagnostics above, turn off your unit immediately and contact an authorized service center.

European Disposal Guidelines

5

This appliance contains refrigerant and other potentially hazardous materials. When disposing of this appliance, the law requires special collection and treatment. **Do not** dispose of this product as household waste or unsorted municipal waste.

When disposing of this appliance, you have the following options:

- Dispose of the appliance at designated municipal electronic waste collection facility.
- When buying a new appliance, the retailer will take back the old appliance free of charge.
- The manufacturer will take back the old appliance free of charge.
- Sell the appliance to certified scrap metal dealers.

Special notice

Disposing of this appliance in the forest or other natural surroundings endangers your health and is bad for the environment. Hazardous substances may leak into the ground water and enter the food chain.

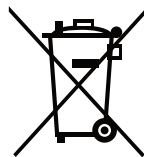

The design and specifications are subject to change without prior notice for product improvement. Consult with the sales agency or manufacturer for details.

Activate your Warranty

- Visit our web site and activate your warranty via the below link or by scanning the QR code

<https://www.inventorairconditioner.com/warranty-inventor>



- Fill all the fields as shown below

To activate the warranty card, please fill in the following fields

Owner details	Unit details
Full Name* <input type="text"/>	Unit Type* <input type="text"/>
Address* <input type="text"/>	Serial Number of the indoor unit* <input type="text"/>
Postal Code* <input type="text"/>	Serial Number of the outdoor unit* <input type="text"/>
Phone Number* <input type="text"/>	Date of Purchase* <input type="text"/>
E-mail* <input type="text"/>	Invoice Number* <input type="text"/>
Subscribe to Inventor's Newsletter <input type="checkbox"/>	Additional Details <input type="text"/>

* Required field
With the current warranty card you accept the terms and conditions.

- once the warranty submission has been completed a confirmation message will be sent to your email

ΠΙΝΑΚΑΣ ΠΕΡΙΕΧΟΜΕΝΩΝ

Εγχειρίδιο Χρήστη

0 Οδηγίες Ασφαλείας04

1 Χαρακτηριστικά και Λειτουργίες της μονάδας ..06



3	Φροντίδα και Συντήρηση	12
4	Σφάλματα	14
5	Ευρωπαϊκές Προδιαγραφές Απόρριψης	18

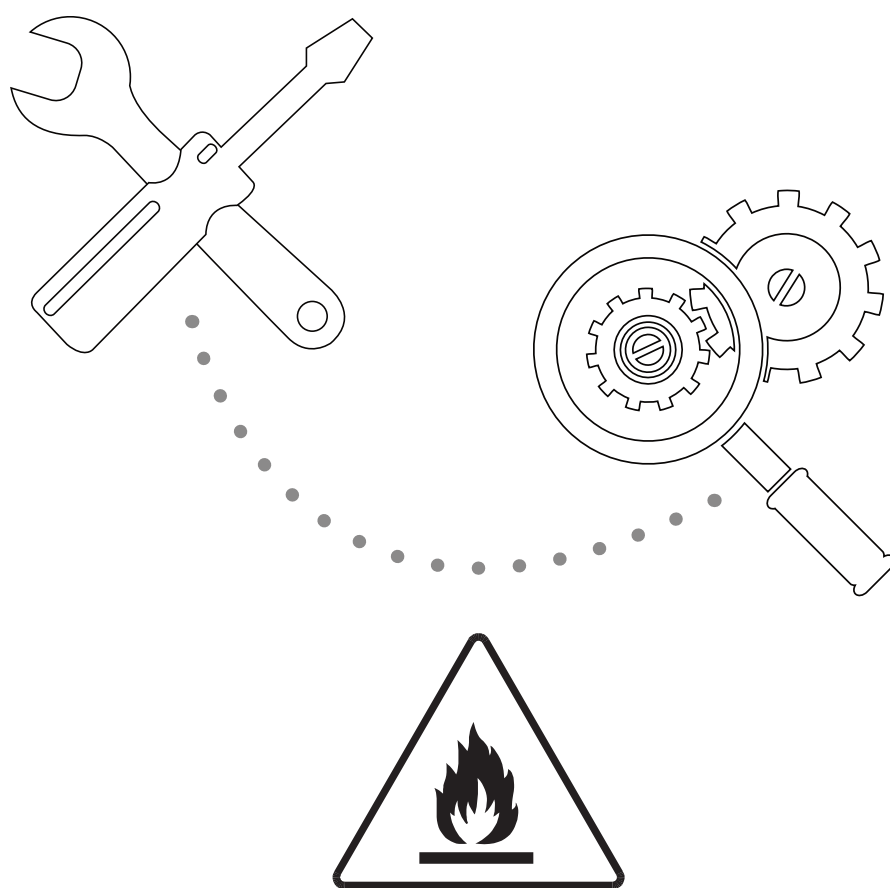

**Προσοχή: Κίνδυνος πυρκαγιάς/
εύφλεκτα αέρια**

ΠΡΟΕΙΔΟΠΟΙΗΣΗ: Η συντήρηση και η επισκευή του κλιματιστικού θα πρέπει να πραγματοποιείται βάσει των οδηγιών που ορίζει ο κατασκευαστής. Η συντήρηση και η επισκευή του κλιματιστικού θα πρέπει να διεξάγεται από αδειοδοτημένο τεχνικό, εξειδικευμένο στη χρήση εύφλεκτων ψυκτικών μέσων. Για περισσότερες λεπτομέρειες, ανατρέξτε στην ενότητα «Πληροφορίες σχετικά με την Επισκευή και Συντήρηση» στο εγχειρίδιο εγκατάστασης.

Οδηγίες Ασφαλείας

Διαβάστε τις Οδηγίες Ασφαλείας Πριν την Εγκατάσταση

Εσφαλμένη εγκατάσταση λόγω αγνόησης των οδηγιών μπορεί να προκαλέσει σοβαρές καταστροφές ή τραυματισμούς. Η σοβαρότητα πιθανών καταστροφών ή τραυματισμών αναφέρεται είτε ως ΠΡΟΕΙΔΟΠΟΙΗΣΗ είτε ως ΠΡΟΣΟΧΗ



ΠΡΟΕΙΔΟΠΟΙΗΣΗ

Αυτό το σύμβολο δείχνει ότι η αγνόησή του μπορεί να προκαλέσει θάνατο ή σοβαρό τραυματισμό.



ΠΡΟΣΟΧΗ

Αυτό το σύμβολο δείχνει ότι αγνοώντας τις οδηγίες μπορεί να προκληθεί τραυματισμός ή καταστροφή στην συσκευή ή σε άλλη ιδιοκτησία.



ΠΡΟΕΙΔΟΠΟΙΗΣΗ

Αυτή η μονάδα μπορεί να χρησιμοποιηθεί από άτομα πάνω από 8 ετών και από άτομα με ειδικές ανάγκες ή έλλειψη εμπειρίας και γνώσης αρκεί να επιβλέπονται από άτομα υπεύθυνα για την ασφαλείά τους. Βεβαιωθείτε πως τα παιδιά δεν παίζουν με τη μονάδα. Ο καθαρισμός και η συντήρησή τους δεν πρέπει να γίνονται χωρίς επίβλεψη

ΠΡΟΕΙΔΟΠΟΙΗΣΕΙΣ ΕΓΚΑΤΑΣΤΑΣΗΣ

- Ρωτήστε εξειδικευμένο εμπορικό δίκτυο για την εγκατάσταση του κλιματιστικού. Εσφαλμένη εγκατάσταση μπορεί να προκαλέσει διαρροή νερού, ηλεκτροπληξία, ή πυρκαγιά.
- Η επισκευή, διατήρηση και μετακίνηση της μονάδας πρέπει να πραγματοποιείται από εξειδικευμένο τεχνικό. Εσφαλμένες επισκευές μπορεί να οδηγήσουν σε τραυματισμούς ή σοβαρές ζημιές στο προϊόν

ΠΡΟΕΙΔΟΠΟΙΗΣΕΙΣ ΚΑΤΑ ΤΗ ΧΡΗΣΗ ΤΟΥ ΠΡΟΪΟΝΤΟΣ

- Αν παρουσιαστεί ασυνήθιστη κατάσταση (όπως μυρωδιά καμμένου), αμέσως απενεργοποιήστε τη μονάδα και αποσυνδέστε από τη πρίζα. Καλέστε τον προμηθευτή σας για οδηγίες ώστε να αποφύγετε ηλεκτροπληξία, φωτιά ή τραυματισμό.
- Μην βάζετε τα δάχτυλά σας, ράβδους ή άλλα αντικείμενα μέσα στην είσοδο και έξοδο αέρα. Αυτό μπορεί να προκαλέσει τραυματισμό, αφού ο ανεμιστήρας μπορεί να περιστρέφεται σε υψηλές ταχύτητες.
- Μην χρησιμοποιείτε εύφλεκτα σπρέυ όπως σπρέυ μαλλιών, βερνίκια ή χρώματα κοντά στη μονάδα. Αυτό μπορεί να προκαλέσει φωτιά ή έκρηξη.
- Μην χρησιμοποιείτε το κλιματιστικό σε μέρη κοντά ή γύρω από εύφλεκτα αέρια. Αποβαλλόμενο αέριο μπορεί να μαζευτεί γύρω από τη μονάδα και να προκαλέσει έκρηξη.
- Μην χρησιμοποιείτε το κλιματιστικό σε δωμάτιο με νερό (πχ. μπάνιο ή δωμάτιο με μπουγάδα). Αυτό μπορεί να προκαλέσει ηλεκτροπληξία και να προκαλέσει καταστροφές στο προϊόν.
- Μην εκθέτετε το σώμα σας ακριβώς μπροστά από το κλιματιστικό για πολλή ώρα.

ΠΡΟΕΙΔΟΠΟΙΗΣΕΙΣ ΡΕΥΜΑΤΟΣ

- Χρησιμοποιήστε συγκεκριμένο καλώδιο παροχής ρεύματος. Αν είναι κατεστραμμένο, θα πρέπει να αντικατασταθεί από τον κατασκευαστή ή από πιστοποιημένο κέντρο σέρβις.
- Κρατήστε καθαρή τη πρίζα. Αφαιρέστε τη σκόνη και τη βρωμιά που έχει συγκεντρωθεί γύρω από τη πρίζα. Βρώμικες πρίζες μπορούν να προκαλέσουν φωτιά ή ηλεκτροπληξία.
- Μην τραβάτε το καλώδιο για να αποσυνδέσετε τη μονάδα. Κρατήστε σταθερά τα δυο μέρη και αφαιρέστε. Τραβώντας απότομα τη πρίζα μπορεί προκληθούν ζημιές, που μπορεί να οδηγήσουν σε φωτιά ή ηλεκτροπληξία.
- Μην χρησιμοποιείτε προέκταση καλωδίου, μην προεκτείνετε χειροκίνητα το καλώδιο και μην συνδέετε άλλες συσκευές στην ίδια πρίζα με το κλιματιστικό. Κακή ηλεκτρολογική σύνδεση, μειωμένη παροχή και αναποτελεσματική τάση μπορεί να προκαλέσουν πυρκαγιά.





ΠΡΟΕΙΔΟΠΟΙΗΣΕΙΣ ΚΑΘΑΡΙΣΜΟΥ ΚΑΙ ΣΥΝΤΗΡΗΣΗΣ

- Απενεργοποιήστε το μηχάνημα και αποσυνδέστε από τη πρίζα πριν καθαρίσετε. Διαφορετικά μπορεί να προκληθεί ηλεκτροπληξία.
- Μην καθαρίζετε το κλιματιστικό με μεγάλες ποσότητες νερού.
- Μην καθαρίζετε το κλιματιστικό με εύφλεκτα μέσα. Εύφλεκτες ουσίες μπορεί να προκαλέσουν φωτιά ή παραμόρφωση.

! ΠΡΟΣΟΧΗ

- Αν το κλιματιστικό χρησιμοποιείτε μαζί με εστίες ή άλλες θερμαντικές συσκευές, αερίστε το δωμάτιο για επαρκές οξυγόνο στο χώρο.
- Απενεργοποιήστε το κλιματιστικό και αποσυνδέστε τη μονάδα αν δεν σκοπεύετε να την χρησιμοποιήσετε για αρκετό καιρό.
- Απενεργοποιήστε και αποσυνδέστε τη μονάδα κατά τη διάρκεια καταιγίδων.
- Βεβαιωθείτε ότι δεν εμποδίζεται η ροή του νερού στο σωλήνα.
- Μην χρησιμοποιείτε τη συσκευή με υγρά χέρια. Μπορεί να προκαλέσει ηλεκτροπληξία.
- Μην χρησιμοποιείτε τη μονάδα για διαφορετικό σκοπό από αυτόν που ενδείκνυται.
- Μην σκαρφαλώνετε και μην τοποθετείτε αντικείμενα πάνω στην εξωτερική μονάδα.
- Μην επιτρέπετε στο κλιματιστικό να λειτουργεί για μεγάλες περιόδους με ανοιχτά τα παράθυρα και τις πόρτες, ή αν η υγρασία είναι πολύ υψηλή.

Επεξήγηση συμβόλων που εμφανίζονται στην εσωτερική ή στην εξωτερική μονάδα: (Για μονάδες με ψυκτικό μέσο R32 / R290):

	ΠΡΟΕΙΔΟ-ΠΟΙΗΣΗ	Αυτό το σύμβολο δείχνει ότι αυτή η συσκευή χρησιμοποιεί εύφλεκτο ψυκτικό μέσο. Αν το ψυκτικό υγρό διαρρεύσει ή εκτεθεί σε εξωτερική εύφλεκτη πηγή, υπάρχει κίνδυνος πυρκαγιάς.
	ΠΡΟΣΟΧΗ	Αυτό το σύμβολο σας ενημερώνει ώστε να διαβάσετε προσεκτικά το εγχειρίδιο λειτουργίας.
	ΠΡΟΣΟΧΗ	Αυτό το σύμβολο δείχνει ότι ο χειρισμός των κλιματιστικών μονάδων πρέπει να πραγματοποιείται μόνο από αδειοδοτημένους τεχνικούς, οι οποίοι οφείλουν να ανατρέχουν στο εγχειρίδιο εγκατάστασης.
	ΠΡΟΣΟΧΗ	Αυτό το σύμβολο δείχνει ότι υπάρχουν διαθέσιμες πληροφορίες αναφορικά με τις λειτουργίες στο εγχειρίδιο χρήστη & το εγχειρίδιο εγκατάστασης.
	ΠΡΟΣΟΧΗ	Αυτό το σύμβολο δείχνει ότι υπάρχουν διαθέσιμες πληροφορίες αναφορικά με τις λειτουργίες στο εγχειρίδιο χρήστη & το εγχειρίδιο εγκατάστασης.

Χαρακτηριστικά και Λειτουργίες της μονάδας

1

Μέρη Μονάδας

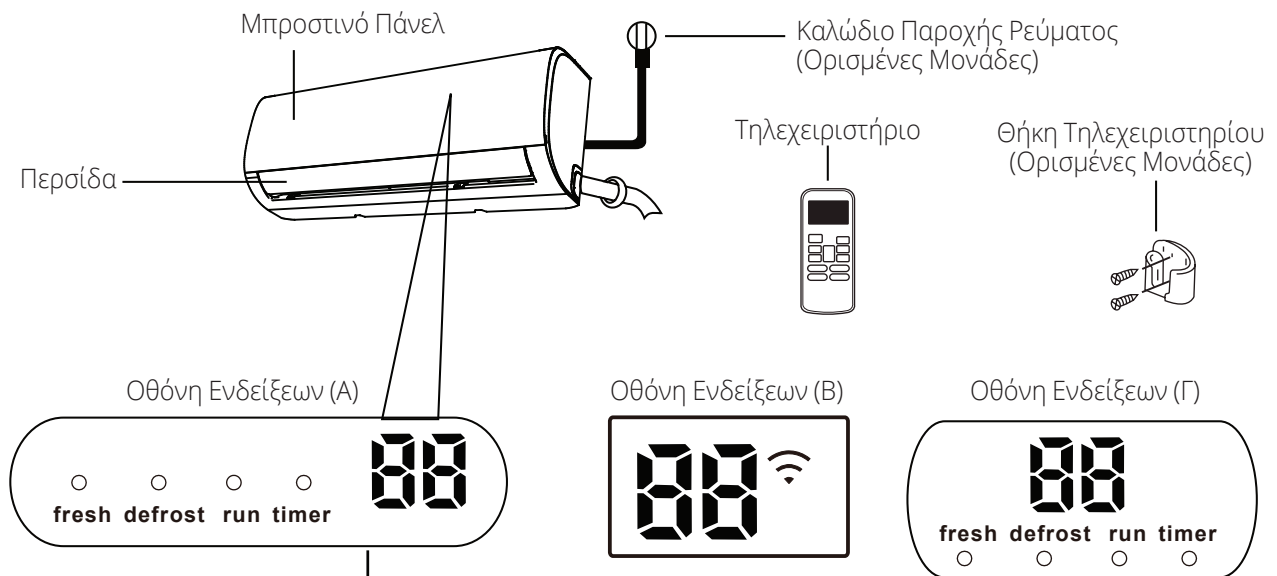

“fresh” όταν η λειτουργία Fresh ενεργοποιηθεί.

“defrost” όταν η λειτουργία απόψυξης ενεργοποιηθεί.

“run” όταν η μονάδα έχει τεθεί σε λειτουργία.

“timer” όταν ρυθμιστεί ο Χρονοδιακόπτης.

“00” Όταν ενεργοποιείται η λειτουργία ECO, η οθόνη φωτίζεται σταδιακά με τα γράμματα **E** -- **F** -- **0** -- ρυθμισμένη θερμοκρασία θα εμφανιστεί με καθυστέρηση 1 δευτερόλεπτο.

Σε άλλες καταστάσεις, η μονάδα εμφανίζει τις ρυθμίσεις θερμοκρασίας.

Σε κατάσταση FAN, η μονάδα θα δείξει τη θερμοκρασία δωματίου.

Όταν παρουσιαστεί κάποια δυσλειτουργία, εμφανίζεται κωδικός βλάβης.

00, για τρία δευτερόλεπτα όταν:

- Timer ON έχει ρυθμιστεί
- Fresh, Swing, Turbo or Silence λειτουργίες είναι ενεργοποιημένες

0F, για τρία δευτερόλεπτα όταν:

- Timer OFF έχει ρυθμιστεί
- Fresh, Swing, Turbo or Silence λειτουργίες απενεργοποιηθούν.

eF όταν ενεργοποιηθεί η λειτουργία προστασίας από ψυχρό αέρα.

dF υπό συνθήκες αποπάγωσης.

SF κατά τη λειτουργία αυτοκαθαρισμού

FP όταν ενεργοποιείται η προστασία από πάγο.

Wi-Fi όταν ενεργοποιείται η λειτουργία WIFI Control.

Σημασία Κωδικών στην Οθόνη

ΣΗΜΕΙΩΣΗ: Ο οδηγός χρήσης του τηλεχειριστηρίου δεν συμπεριλαμβάνεται σε αυτό το πακέτο.

ΒΕΛΤΙΣΤΗ ΑΠΟΔΟΣΗ

Ιδανική Απόδοση για καταστάσεις COOL, HEAT και DRY μπορεί να επιτευχθεί στο ακόλουθο θερμοκρασιακό εύρος. Όταν το κλιματιστικό λειτουργεί πέραν αυτού του εύρους, συγκεκριμένες λειτουργίες προστασίας θα ενεργοποιηθούν και θα κάνουν τη μονάδα να αποδίδει λιγότερο από το βέλτιστο.

Μονάδα Inverter

	ΨΥΞΗ	ΘΕΡΜΑΝΣΗ	ΑΦΥΓΡΑΝΣΗ
Θερμοκρασία Δωματίου	17°C - 32°C (63°F - 90°F)	0°C - 30°C (32°F - 86°F)	10°C - 32°C (50°F - 90°F)
Εξωτερική Θερμοκρασία	0°C - 50°C (32°F - 122°F)	-15°C - 30°C (5°F - 86°F)	0°C - 50°C (32°F - 122°F)
	-15°C - 50°C (5°F - 122°F) (Για μοντέλα με σύστημα χαμηλής θερμοκρασίας)		
	0°C - 60°C (32°F - 140°F) Για ειδικά μοντέλα		

ΓΙΑ ΜΟΝΑΔΕΣ ΜΕ ΒΟΗΘΗΤΙΚΑ ΘΕΡΜΑΝΤΙΚΑ ΣΩΜΑΤΑ

Όταν η εξωτερική θερμοκρασία είναι κάτω από 0°C, συνιστούμε να κρατήσετε συνδεδεμένο στη πρίζα το κλιματιστικό σας για να διασφαλίσετε την απόδοσή του.

Τύπος Σταθερών Στροφών

	ΨΥΞΗ	ΘΕΡΜΑΝΣΗ	ΑΦΥΓΡΑΝΣΗ
Θερμοκρασία Δωματίου	17°-32°C (63°-90°F)	0°-30°C (32°-86°F)	13°-32°C (50°-90°F)
Εξωτερική Θερμοκρασία	18°-43°C (64°-109°F)	-7°-24°C (19°-75°F)	18°-43°C (64°-109°F)
	-7°-43°C (19°-109°F) (Για μοντέλα με σύστημα χαμηλής θερμοκρασίας)		18°-43°C (64°-109°F)
	18°-54°C (64°-129°F) Για ειδικά μοντέλα		18°-54°C (64°-129°F) Για ειδικά μοντέλα

Για ακόμα πιο βέλτιστη απόδοση της μονάδας, ακολουθήστε:

- Κρατήστε τις πόρτες και τα παράθυρα κλειστά.
- Περιορισμένη κατανάλωση ενέργειας μέσω λειτουργιών TIMER ON και TIMER OFF.
- Μην μπλοκάρτε τις εισόδους και εξόδους αέρα.
- Επιθεωρείτε και καθαρίζετε συχνά τα φίλτρα.

Για λεπτομερή επεξήγηση κάθε λειτουργίας, ανατρέξτε στο εγχειρίδιο του τηλεχειριστηρίου.

Άλλες λειτουργίες

• Αυτόματη Επανεκκίνηση

Μετά τη διακοπή ρεύματος, η μονάδα θα επανεκκινηθεί αυτόματα με τις αρχικές ρυθμίσεις μόλις επανέλθει το ρεύμα.

• Αποφυγή δημιουργίας μούχλας

Όταν απενεργοποιήσετε τη μονάδα από καταστάσεις COOL, AUTO (COOL) ή DRY, το κλιματιστικό θα συνεχίσει να λειτουργεί σε χαμηλή ταχύτητα για να απομακρύνει την υγρασία και να αποφευχθεί η δημιουργία μούχλας.

• Ανίχνευση διαρροών ψυκτικού υγρού

Όταν ανιχνεύεται διαρροή ψυκτικού υγρού η εσωτερική μονάδα θα εμφανίσει τον κωδικό EC αυτόματα.

• Λειτουργία WiFi ελέγχου

Η σύνδεση με WiFi με την μονάδα σας επιτρέπει να μπορείτε να ελέγχεται ασύρματα με το κινητό τηλέφωνο σας το κλιματιστικό.

Για την πρόσβαση στη συσκευή USB, οι διαδικασίες αντικατάστασης και συντήρησης θα πρέπει να πραγματοποιούνται από εξειδικευμένο προσωπικό.

• Απομνημόνευση θέσης περσίδων

Όταν ενεργοποιήσετε τη μονάδα η θέση της περσίδας αποθηκεύεται στην μνήμη και θα επιστρέψει στη θέση που είχε επιλεγεί τελευταία φορά από το χρήστη.

Για λεπτομερή επεξήγηση των προχωρημένων λειτουργιών της μονάδας (όπως TURBO κατάσταση και αυτοκαθαρισμού λειτουργία), ανατρέξτε στο εγχειρίδιο χρήσης του τηλεχειριστηρίου

ΣΗΜΕΙΩΣΗ ΣΤΗΝ ΕΙΚΟΝΟΓΡΑΦΗΣΗ

Οι εικονογραφήσεις σε αυτό το εγχειρίδιο είναι για επεξηγηματικούς σκοπούς. Το πραγματικό σχήμα της εσωτερικής μονάδας μπορεί να διαφέρει ελαφρώς. Ισχύει το πραγματικό σχήμα.

• Ρυθμίζοντας τη γωνία διάχυσης του αέρα

Ρυθμίζοντας οριζόντια γωνία διάχυσης του αέρα

Η οριζόντια διάχυση του αέρα πρέπει να ρυθμιστεί χειροκίνητα. Μετακινήστε τον μοχλό εκτροπής (Βλέπε Εικ. Β) και χειροκίνητα προσαρμόστε το στην επιθυμητή κατεύθυνση. Για κάποιες μονάδες, η οριζόντια γωνία διάχυσης μπορεί να ρυθμιστεί από το τηλεχειριστήριο. Παρακαλείσθε να αντρέξετε στο εγχειρίδιο χρήσης του τηλεχειριστηρίου.

ΣΗΜΕΙΩΣΗ ΓΙΑ ΤΙΣ ΓΩΝΙΕΣ ΠΕΡΣΙΔΩΝ

Όταν χρησιμοποιείτε λειτουργία COOL ή DRY, μην βάζετε τη περσίδα σε πολύ κάθετη γωνία για μεγάλες περιόδους. Αυτό μπορεί να προκαλέσει διαρροή νερού στο φύλλο της περσίδας, το οποίο θα πέσει στο πάτωμα ή στα έπιπλα. (Βλέπε Εικ. Α)

Όταν χρησιμοποιείτε λειτουργία ΨΥΞΗΣ ή ΘΕΡΜΑΝΣΗΣ, η ρυθμισμένη περσίδα σε κάθετη γωνία μπορεί να μειώσει την απόδοση της μονάδας λόγω περιορισμένης ροής του αέρα.

Μην μετακινείτε τη περσίδα χειροκίνητα. Αυτό μπορεί να έχει σαν αποτέλεσμα τη παρεμπόδιση του συγχρονισμού της περσίδας. Αν αυτό συμβεί, απενεργοποιήστε τη μονάδα και αποσυνδέστε τη για μερικά δευτερόλεπτα και επανεκκινήστε. Αυτό θα επαναφέρει τη περσίδα.

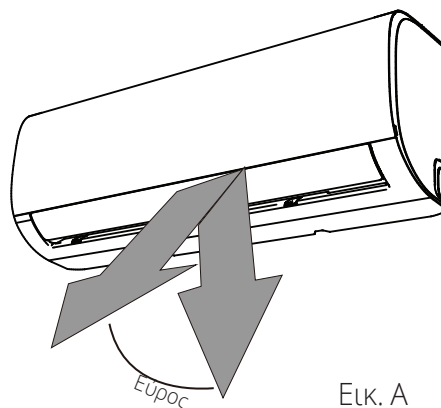

Εικ. Α

Προσοχή: Μην κρατάτε τη περσίδα σε πολύ κάθετη γωνία για πολύ μεγάλο χρονικό διάστημα. Αυτό μπορεί να προκαλέσει διαρροή νερού πάνω στα έπιπλά σας.

! ΠΡΟΣΟΧΗ

Μην βάζετε τα δάχτυλά σας κοντά στη έξοδο του αέρα. Η υψηλή ταχύτητα του αέρα μέσα στη μονάδα μπορεί να προκαλέσει τραυματισμούς.

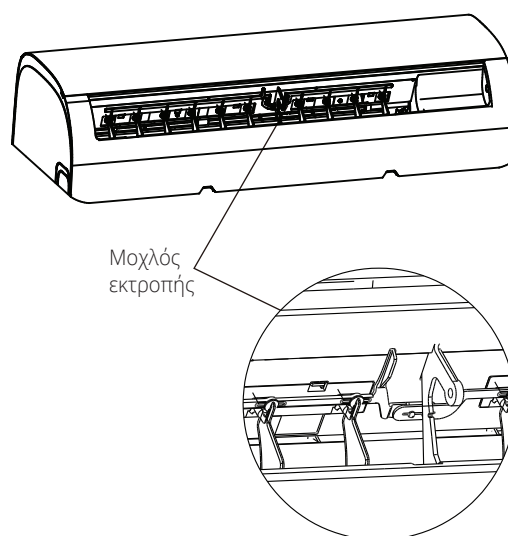

Εικ. Β

• Λειτουργία Ύπνου

Η λειτουργία SLEEP χρησιμοποιείτε για να μειώνει την κατανάλωση ενέργειας κατά τη διάρκεια του ύπνου (και δεν χρειάζεται τις ίδιες ρυθμίσεις θερμοκρασίας για άνετο περιβάλλον). Αυτή η λειτουργία μπορεί να ενεργοποιηθεί μόνο από το τηλεχειριστήριο.

Πιέστε το πλήκτρο SLEEP όταν είστε έτοιμοι να πάτε για ύπνο. Όταν είναι σε κατάσταση ΨΥΞΗΣ, η μονάδα θα αυξήσει τη θερμοκρασία από 1° (2°F) μετά από 1 ώρα και θα αυξήσει ακόμα 1° (2°F) την επόμενη ώρα. Όταν είναι σε κατάσταση ΘΕΡΜΑΝΣΗΣ, η μονάδα θα μειώσει τη θερμοκρασία σε 1° (2°F) μετά από μια ώρα, και θα τη μειώσει ακόμα 1° (2°F) μετά από μια ώρα.

Θα διατηρήσει τη νέα θερμοκρασία για 7 ώρες και μετά θα απενεργοποιηθεί αυτόματα.

ΣΗΜΕΙΩΣΗ: Η λειτουργία SLEEP δεν είναι διαθέσιμη σε κατάσταση FAN ή DRY.

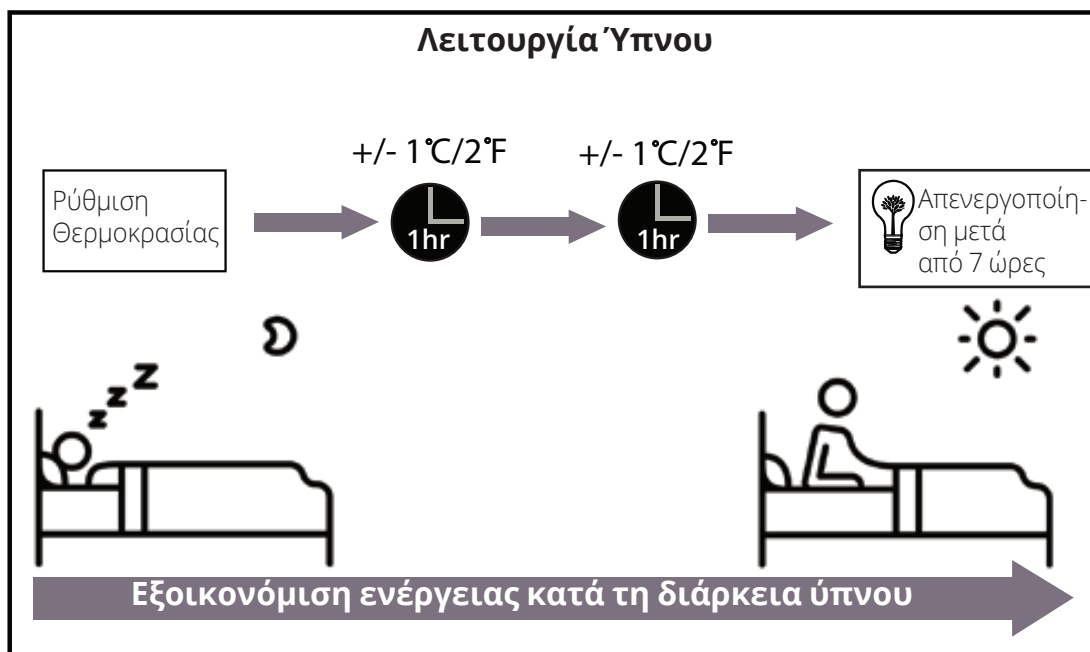

Χειροκίνητη λειτουργία (Χωρίς τηλεχειριστήριο)

2

Πώς να λειτουργήσετε τη μονάδα χωρίς τηλεχειριστήριο

Στη περίπτωση που το τηλεχειριστήριο δεν δουλεύει, το κλιματιστικό μπορεί να λειτουργήσει και χειροκίνητα με το MANUAL CONTROL κουμπί που βρίσκεται στην εσωτερική μονάδα. Σημειώστε ότι η χειροκίνητη λειτουργία δεν είναι μακροπρόθεσμη λύση και αυτό που συστήνεται είναι η χρήση της μονάδας με το τηλεχειριστήριο.

ΠΡΙΝ ΤΗΝ ΧΕΙΡΟΚΙΝΗΤΗ ΛΕΙΤΟΥΡΓΙΑ

Η μονάδα πρέπει να απενεργοποιείται πριν τη χειροκίνητη λειτουργία της.

Για να λειτουργήσετε το κλιματιστικό σας χειροκίνητα:

1. Ανοίξτε το μπροστινό πάνελ της εσωτερικής μονάδας.
2. Βρύν το MANUAL CONTROL κουμπί στη δεξιά πλευρά του πάνελ της μονάδας
3. Πατήστε το MANUAL CONTROL κουμπί μια φορά να ενεργοποιήσετε ξανά τη κατάσταση FORCED AUTO.
4. Πατήστε το MANUAL CONTROL κουμπί ξανά να ενεργοποιήσετε τη κατάσταση FORCED COOLING.
5. Πατήστε το MANUAL CONTROL κουμπί τρίτη φορά να κλείσετε το κλιματιστικό.
6. Κλείστε το πάνελ της εσωτερικής μονάδας.

! ΠΡΟΣΟΧΗ

Το κουμπί manual στοχεύει σε έλεγχο και έκτακτης ανάγκης λειτουργία μόνο. Παρακαλείσθε να μην χρησιμοποιείτε αυτή τη λειτουργία εκτός αν έχετε χάσει το τηλεχειριστήριο και είναι απολύτως αναγκαίο. Για να επαναφέρετε τις κανονικές λειτουργίες, χρησιμοποιήστε το τηλεχειριστήριο να ενεργοποιήσετε τη μονάδα.

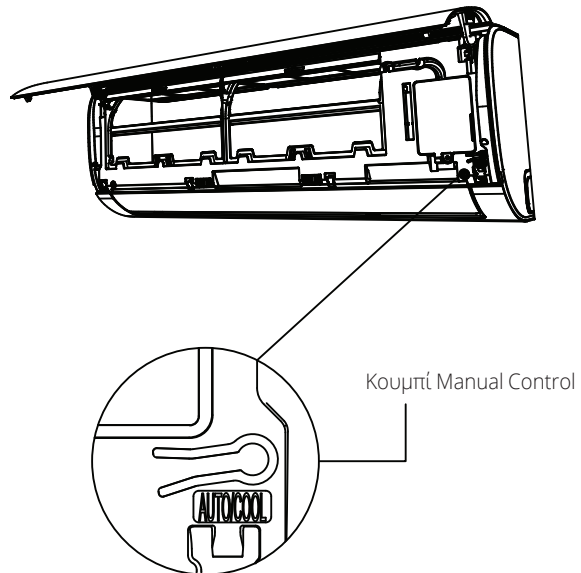

Καθαρισμός και Συντήρηση

3

Καθαρισμός Εσωτερικής Μονάδας

! ΠΡΙΝ ΤΟΝ ΚΑΘΑΡΙΣΜΟ Ή ΤΗ ΣΥΝΤΗΡΗΣΗ

**ΑΠΕΝΕΡΓΟΠΟΙΕΙΤΕ ΤΟ ΚΛΙΜΑΤΙΣΤΙΚΟ
ΚΑΙ ΑΠΟΣΥΝΔΕΣΤΕ ΤΗ ΠΑΡΟΧΗ
ΡΕΥΜΑΤΟΣ ΠΡΙΝ ΤΟΝ ΚΑΘΑΡΙΣΜΟ ΚΑΙ
ΤΗ ΣΥΝΤΗΡΗΣΗ.**

! ΠΡΟΣΟΧΗ

Εάν η εσωτερική μονάδα είναι πολύ βρώμικη, μπορείτε να την καθαρίσετε με ένα βρεγμένο πανί και έπειτα να σκουπίσετε με ένα στεγνό πανί.

- **Μην** χρησιμοποιείτε χημικά ή επεξεργασμένο ξεσκονόπανο για τον καθαρισμό.
- **Μην** χρησιμοποιείτε βενζίνη, διαλυτικά, στιλβωτικά ή παρόμοια διαλύματα για τον καθαρισμό. Μπορεί να προκαλέσουν παραμόρφωση ή ράγισμα στις πλαστικές επιφάνειες της μονάδας.
- **Μην** χρησιμοποιείτε για τον καθαρισμό του μπροστινού πάνελ νερό πάνω από 40°C (104°F). Μπορεί να προκληθεί παραμόρφωση ή αποχρωματισμός.

Καθαρισμός του Φίλτρου Αέρα

Ένα φραγμένο κλιματιστικό μπορεί μειώνει την απόδοση της μονάδας και να είναι βλαβερό για την υγεία σας. Παρακαλούμε να καθαρίζετε τα φίλτρα κάθε 15 ημέρες.

1. Ανασηκώστε το μπροστινό πάνελ της εσωτερικής μονάδας.
2. Πρώτα πιέστε την γλωττίδα στο άκρο του φίλτρου ώστε να το αποδεσμεύσετε, ανασηκώστε την και στη συνέχεια τραβήξτε την προς τα έξω.
3. Αφαιρέστε το φίλτρο.
4. Εάν το φίλτρο σας διαθέτει μικρό φίλτρο για την ανανέωση του αέρα, αποσυνδέστε το από το μεγαλύτερο φίλτρο. Καθαρίστε αυτό το φίλτρο.
5. Καθαρίστε το μεγάλο φίλτρο αέρα με ζεστό, σαπουνώδες νερό. Βεβαιωθείτε ότι χρησιμοποιείτε ήπιο απορρυπαντικό.

6. Καθαρίστε το φίλτρο με φρέσκο νερό, μετά κουνήστε το για να διώξετε το νερό.
7. Στεγνώστε το σε ψυχρό, χωρίς υγρασία δωμάτιο και αποφύγετε την έκθεσή του στον ήλιο.
8. Όταν στεγνώσει, επανατοποθετήστε το φίλτρο ανανέωσης αέρα στο μεγαλύτερο φίλτρο και στη συνέχεια, επανατοποθετήστε το στην εσωτερική μονάδα.
9. Κλείστε το πάνελ της εσωτερικής μονάδας.

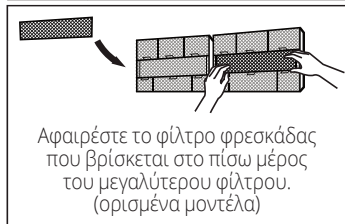
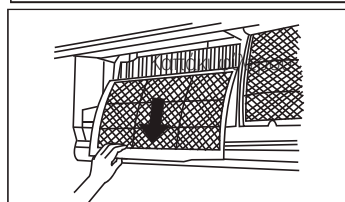
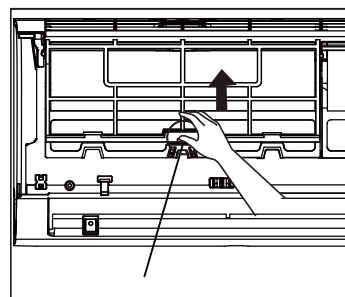

Αφαιρέστε το φίλτρο φρεσκάδας που βρίσκεται στο πίσω μέρος του μεγαλύτερου φίλτρου. (ορισμένα μοντέλα)

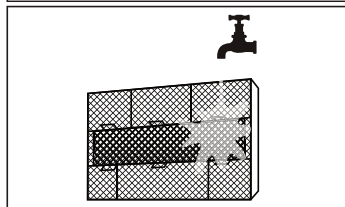

! ΠΡΟΣΟΧΗ

Μην αγγίζεται το φίλτρο του κλιματιστικού (Plasma) για τουλάχιστον 10 λεπτά αφότου απενεργοποιήσετε τη μονάδα.

! ΠΡΟΣΟΧΗ

- Πριν αλλάξετε τα φίλτρα ή τα καθαρίσετε, απενεργοποιήστε τη μονάδα και αποσυνδέστε από τη παροχή ρεύματος.
- Όταν μετακινείτε τα φίλτρα, μην αγγίζετε τα μεταλλικά μέρη της μονάδας, υπάρχει κίνδυνος τραυματισμού.
- Μην χρησιμοποιείτε νερό για να καθαρίσετε το εσωτερικό μέρος της εσωτερικής μονάδας. Αυτό μπορεί να καταστρέψει τη μόνωση και να προκαλέσει ηλεκτροπληξία.
- Μην εκθέτετε το φίλτρο απευθείας στην ηλιακή ακτινοβολία. Μπορεί να συρρικνωθεί.

! ΠΡΟΣΟΧΗ

- Οποιαδήποτε διατήρηση ή καθαρισμός της εξωτερικής συσκευής πρέπει να πραγματοποιείται από εξουσιοδοτημένο προμηθευτή ή εξειδικευμένο κέντρο σέρβις.
- Κάθε επισκευή κλιματιστικού πρέπει να πραγματοποιείται από εξουσιοδοτημένο προμηθευτή ή εξειδικευμένο κέντρο σέρβις.

Συντήρηση- Μεγάλες Περίοδοι Μη -Χρήσης

Αν σχεδιάζετε να μην χρησιμοποιήσετε το κλιματιστικό για μεγάλο διάστημα, ακολουθήστε τα παρακάτω:

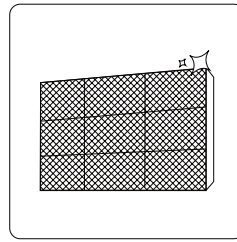

Καθαρίστε όλα τα φίλτρα

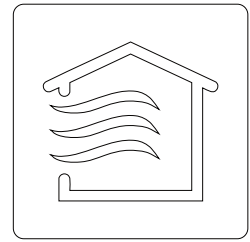

Ενεργοποιήστε τη λειτουργία FAN μέχρι να στεγνώσει η μονάδα τελείως



Απενεργοποιήστε τη μονάδα και αποσυνδέστε τη από το ρεύμα

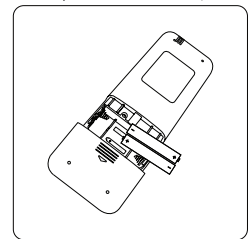

Αφαιρέστε τις μπαταρίες από το τηλεχειριστήριο

Συντήρηση- Πριν την έναρξη της περιόδου χρήσης

Μετά από μεγάλες περιόδους μη χρήσης της συσκευής ή συνεχόμενης χρήσης της, κάντε τα ακόλουθα:

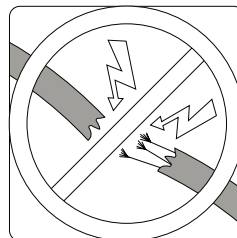

Έλεγχος για κατεστραμμένα καλώδια

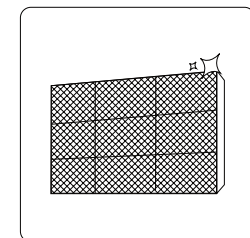

Καθαρίστε όλα τα φίλτρα



Έλεγχος για διαρροές

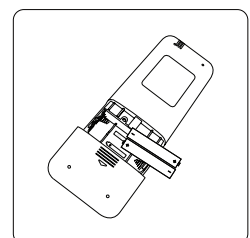

Αντικαταστήστε τις μπαταρίες

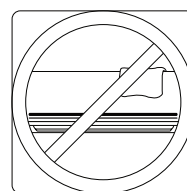

Βεβαιωθείτε ότι τίποτα δεν εμποδίζει όλες τις εισόδους και εξόδους αέρα

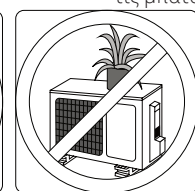

! ΟΔΗΓΙΕΣ ΑΣΦΑΛΕΙΑΣ

Αν κάποια από τις ακόλουθες συνθήκες συμβαίνει, απενεργοποιήστε το κλιματιστικό σας αμέσως!

- Το καλώδιο παροχής είναι κατεστραμμένο ή ασυνήθιστα ζεστό
- Μυρίζετε μια περίεργη μυρωδιά
- Η μονάδα βγάζει θόρυβο ή ασυνήθιστους ήχους
- Καίγεται συχνά η ασφάλεια ή πέφτει ο ασφαλειοδιακόπτης
- Έπεσε νερό ή άλλο αντικείμενο μέσα στη μονάδα

ΜΗΝ ΠΡΟΣΠΑΘΗΣΤΕ ΝΑ ΕΠΙΔΙΟΡΘΩΣΤΕ ΜΟΝΟΙ ΣΑΣ! ΕΠΙΚΟΙΝΩΝΗΣΤΕ ΜΕ ΕΞΟΥΣΙΟΔΟΤΗΜΕΝΟ ΚΕΝΤΡΟ ΣΕΡΒΙΣ ΑΜΕΣΩΣ!

Κοινά ζητήματα

Τα ακόλουθα προβλήματα δεν αποτελούν δυσλειτουργίες και στις περισσότερες περιπτώσεις δεν χρίζουν επισκευής.

Ζήτημα	Πιθανά Αίτια
Η μονάδα δεν ενεργοποιείται όταν πατάτε το κουμπί ON/OFF	Η μονάδα έχει 3 λεπτών λειτουργία προστασίας για να προφυλάξει το κλιματιστικό από υπερφόρτωση. Η μονάδα δεν μπορεί να επανεκκινηθεί μέσα σε αυτά τα 3 λεπτά που είναι απενεργοποιημένη.
Η μονάδα αλλάζει από κατάσταση ΨΥΞΗΣ/ΘΕΡΜΑΝΣΗΣ σε FAN κατάσταση	Η μονάδα αλλάζει τις ρυθμίσεις ώστε να αποφύγει την δημιουργία πάγου. Από τη στιγμή που αυξηθεί μια φορά η θερμοκρασία, η μονάδα θα αρχίσει να λειτουργεί με βάση τις προηγούμενες ρυθμίσεις ξανά.
	Έχει επιτευχθεί η επιθυμητή θερμοκρασία και σε αυτό το σημείο ο συμπιεστής απενεργοποιείται. Η μονάδα θα επανενεργοποιηθεί όταν η θερμοκρασία διακυμανθεί ξανά.
Η εσωτερική μονάδα αποβάλλει νεφέλωμα	Σε μέρη με υγρασία, μεγάλη διαφορά θερμοκρασίας μεταξύ του αέρα του δωματίου και του κλιματιστικού μπορεί να προκαλέσει νεφέλωμα.
Η εσωτερική και εξωτερική μονάδα αποβάλλει νεφέλωμα	Όταν η μονάδα επανεκκινηθεί σε κατάσταση ΘΕΡΜΑΝΣΗΣ μετά από αποπάγωση λευκό νεφέλωμα μπορεί να αποβληθεί λόγω της υγρασίας που δημιουργείται από τη διαδικασία αποπάγωσης.

Ζήτημα	Πιθανά Αίτια
Η εσωτερική μονάδα κάνει θόρυβο	Ήχος από τον αέρα μπορεί να προκληθεί όταν η περσίδα επαναρυθμίζει τη θέση της.
	Έντονος ήχος μπορεί να προκληθεί αφότου λειτουργήσει η μονάδα σε κατάσταση ΘΕΡΜΑΝΣΗΣ λόγω της επέκτασης και συστολής των πλαστικών μερών της μονάδας.
Η εσωτερική και εξωτερική μονάδα κάνουν θόρυβο	Χαμηλός ήχος σφυρίγματος κατά τη διάρκεια λειτουργίας: Αυτό είναι φυσιολογικό και προκαλείται από το ψυκτικό υγρό που ρέει στην εσωτερική και εξωτερική μονάδα.
	Χαμηλός ήχος σφυρίγματος κατά τη διάρκεια λειτουργίας: Αυτό είναι φυσιολογικό και προκαλείται από το ψυκτικό υγρό που ρέει στην εσωτερική και εξωτερική μονάδα.
	Έντονος ήχος: Φυσιολογική επέκταση και συστολή των πλαστικών και μεταλλικών και προκαλείται από τις θερμοκρασιακές αλλαγές κατά τη διάρκεια της λειτουργίας.
Η εξωτερική μονάδα κάνει θόρυβο	Η μονάδα μπορεί να κάνει διάφορους ήχους βάση της τρέχουσας κατάστασης λειτουργίας.
Σκόνη αποβάλλεται από την εσωτερική ή από την εξωτερική μονάδα	Η μονάδα μπορεί να συσσωρεύει σκόνη αν δεν χρησιμοποιείται για μεγάλες περιόδους, που μπορεί να αποβληθεί κατά την εκκίνησή του. Αυτό μπορεί να περιοριστεί με το να καλύψετε τη μονάδα σε περιόδους μη λειτουργίας.
Η μονάδα αποβάλλει άσχημη μυρωδιά	Η μονάδα μπορεί να απορροφά μυρωδιές από το περιβάλλον (όπως έπιπλα, μαγειρική, τσιγάρα κλπ) τα οποία αποβάλλονται κατά τη λειτουργία.
	Τα φίλτρα της μονάδας έχουν μουχλιάσει και πρέπει να καθαριστούν.
Ο ανεμιστήρας της εξωτερικής μον. δεν λειτουργεί	Κατά τη λειτουργία, η ταχύτητα του ανεμιστήρα ελέγχεται για βέλτιστη απόδοση.
Η λειτουργία είναι ανώμαλη, απρόβλεπτη ή η μονάδα δεν ανταποκρίνεται	Παρεμβολές από τη κεραία της κινητής συσκευής και των ενισχυτών μπορεί να προκαλέσει δυσλειτουργία. Σε αυτή τη περίπτωση, δοκιμάστε: <ul style="list-style-type: none"> • Αποσυνδέστε από τη πρίζα, ξανά συνδέστε. • Πατήστε το κουμπί ON/OFF ώστε να επανεκκινήσετε τη λειτουργία.

ΣΗΜΕΙΩΣΗ: Αν το πρόβλημα συνεχίσει να υπάρχει, επικοινωνήστε με τον τοπικό προμηθευτή ή το κοντινότερο κέντρο σέρβις. Επεξηγήστε λεπτομερώς τη δυσλειτουργία της μονάδας καθώς και τον αριθμό του μοντέλου.

ΣΦΑΛΜΑΤΑ

Όταν συμβεί κάποιο σφάλμα, παρακαλούμε ελέγξτε τα ακόλουθα πριν επικοινωνήσετε με την εταιρία επισκευής.

Ζήτημα	Πιθανά Αίτια	Λύση
Μειωμένη Απόδοση Ψύξης	Η ρύθμιση της θερμοκρασίας μπορεί να είναι υψηλότερη από τη θερμοκρασία περιβάλλοντος	Ρύθμιση χαμηλότερης θερμοκρασί
	Ο εναλλάκτης θερμότητας στην εσωτερική ή εξωτερική μονάδα είναι βρώμικος.	Καθαρίστε τον εναλλάκτη θερμότητας
	Το φίλτρο αέρα είναι βρώμικο	Αφαιρέστε το φίλτρο και καθαρίστε σύμφωνα με τις οδηγίες
	Η είσοδος ή έξοδος αέρα της κάθε μονάδας είναι φρακαρισμένη	Απενεργοποιήστε τη μονάδα, αφαιρέστε τα εμπόδια και επανενεργοποιήστε
	Οι πόρτες και τα παράθυρα είναι ανοιχτά	Βεβαιωθείτε ότι όλες οι πόρτες και τα παράθυρα είναι κλειστά κατά τη διάρκεια λειτουργίας της μονάδας
	Υπερβολική Θερμότητα παράγεται από την ηλιακή ακτινοβολία	Κλείστε τα παράθυρα και τις κουρτίνες κατά τις περιόδους αυξημένης θερμότητας ή ηλιοφάνειας
	Υπερβολικές πηγές θέρμανσης στο δωμάτιο (άνθρωποι, υπολογιστές, ηλεκτρονικές συσκευές κλπ)	Μειώστε τις ποσότητες από τις θερμαντικές πηγές
	Μειωμένο ψυκτικό υγρό λόγω διαρροής ή παρατεταμένης χρήσης	Έλεγχος για διαρροές, κουμπώστε ξανά αν είναι αναγκαίο και γεμίστε με υγρό
	Λειτουργία SILENCE είναι ενεργοποιημένη	Λειτουργία SILENCE μπορεί μειώσει την απόδοση μειώνοντας τις στροφές λειτουργίας. Απενεργοποιήστε τη λειτουργία SILENCE.

Ζήτημα	Πιθανά Αίτια	Λύση
Η μονάδα δεν δουλεύει	Διακοπή Ρεύματος	Αναμονή να επανέλθει το ρεύμα
	Αποσύνδεση από το ρεύμα	Επανεσύνδεση με το ρεύμα
	Καμμένη ασφάλεια	Αντικατάσταση Ασφάλειας
	Έχουν τελειώσει οι μπαταρίες	Αντικαταστήστε τις μπαταρίες
	Η 3 λεπτών προστασία της μονάδας έχει ενεργοποιηθεί	Περιμένετε 3 λεπτά αφότου επανεκκινήσετε τη μονάδα
	Ο Χρονοδιακόπτης έχει ενεργοποιηθεί	Ο Χρονοδιακόπτης έχει απενεργοποιηθεί
Η μονάδα ξεκινάει και σταματάει συχνά	Υπάρχει πολύ ή λίγο ψυκτικό στο σύστημα	Ελέγξτε για διαρροές και ξανά γεμίστε το σύστημα με ψυκτικό υγρό.
	Ασυμπίεστο αέριο ή υγρασία έχει εισέλθει στο σύστημα.	Αδειάστε και ξανά γεμίστε το σύστημα με ψυκτικό υγρό.
	Ο συμπιεστής είναι χαλασμένος	Αντικαταστήστε το συμπιεστή
	Η τάση είναι πολύ υψηλή ή χαμηλή	Εγκαταστήστε ένα μανόμετρο να ρυθμίσετε τη τάση
Μειωμένη απόδοση θέρμανσης	Η εξωτερική θερμοκρασία είναι χαμηλότερη από 7°C (44.5°F)	Χρησιμοποιήστε βοηθητικά θερμαντικά σώματα
	Κρύος αέρας εισέρχεται από πόρτες και παράθυρα	Βεβαιώστε ότι όλες οι πόρτες και τα παράθυρα είναι κλειστά κατά τη διάρκεια της χρήσης
	Μειωμένο ψυκτικό υγρό λόγω διαρροής ή παρατεταμένης χρήσης	Ελέγξτε για διαρροές, κουμπώστε αν είναι απαραίτητο και ξανά γεμίστε με ψυκτικό υγρό.
Οι ενδεικτικές λυχνίες συνεχίζουν να αναβοσβήνουν Εάν στην οθόνη εμφανίζεται ένας από τους παρακάτω κωδικούς: - E0, E1, E2... - P1, P2, P3... - F1, F2, F3...	Η μονάδα μπορεί να σταματήσει τη λειτουργία ή να τεθεί σε λειτουργία ασφαλείας. Περιμένετε 10 λεπτά αν συνεχίσει να αναβοσβήνει ή εμμανιστούν οι κωδικοί σφαλμάτων μήπως η μονάδα επανέλθει από μόνη της. Αν όχι αποσυνδέστε τη από την παροχή ρεύματος και επανασυνδέστε τη. Ενεργοποιήστε τη μονάδα. Εάν το πρόβλημα παραμείνει αποσυνδέστε τη μονάδα από το ρεύμα και επικοινωνήστε με το κοντινότερο κέντρο σέρβις.	

ΣΗΜΕΙΩΣΗ: Εάν το σφάλμα παραμείνει παρά τους ελέγχους και τις διαγνώσεις, απενεργοποιήστε τη μονάδα αμέσως και επικοινωνήστε με ένα εξουσιοδοτημένο κέντρο σέρβις.

Ευρωπαϊκές Προδιαγραφές Απόρριψης

5

Αυτή η συσκευή εμπεριέχει ψυκτικό και άλλα πιθανώς επικίνδυνα υλικά. Όταν απορρίπτετε τη συσκευή, ο νόμος προϋποθέτει ειδική περισυλλογή και μεταχείριση. Μην απορρίπτετε το προϊόν σαν οικιακά ή μη διαχωρισμένα αστικά απορρίματα.

Όταν απορρίπτετε τη συσκευή, έχετε τις ακόλουθες περιπτώσεις:

- Απορρίψτε τη συσκευή σε ενδεδειγμένες μονάδες απόρριψης ηλεκτρονικών συσκευών.
- Όταν αγοράζετε νέα συσκευή, ο έμπορος θα πάρει πίσω τη παλιά συσκευή χωρίς χρέωση.
- Ο κατασκευαστής θα πάρει πίσω τη παλιά συσκευή χωρίς χρέωση.
- Πουλήστε τη συσκευή σε πιστοποιημένο έμπορο άχρηστων μετάλλων.

Ειδική Παρατήρηση

Η απόρριψη αυτής της συσκευής σε δάσος ή άλλο φυσικό περιβάλλον θέτει σε κίνδυνο την υγεία σας και είναι βλαβερό για το περιβάλλον. Επικίνδυνες ουσίες μπορεί να διαρρεύσουν στα υπόγεια ύδατα και να εισέλθουν στη τροφική αλυσίδα.

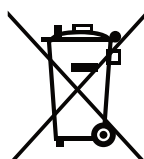

Ο σχεδιασμός και οι προδιαγραφές μπορεί να υποστούν αλλαγές χωρίς προηγούμενη ειδοποίηση, λόγω συνεχούς βελτίωσης του προϊόντος. Συμβουλευτείτε τον αντιπρόσωπο από όπου προμηθευτήκατε το κλιματιστικό σας ή τον κατασκευαστή για περισσότερες λεπτομέρειες.

Υποβολή Εγγύησης

- Επισκεφθείτε τη σελίδα μας και ενεργοποιήστε την εγγύησή σας μέσω του παρακάτω link ή σκανάροντας το QR code

<https://www.inventoraircondition.gr/egiisi-inventor>



- Συμπληρώστε όλα τα πεδία όπως φαίνονται παρακάτω

Για να ενεργοποιήσετε την εγγύηση, παρακαλούμε συμπληρώστε τα παρακάτω πεδία

Στοιχεία ιδιοκτήτη

Όνοματεπώνυμο*

Διεύθυνση*

Τ.Κ.*

Τηλέφωνο*

Διεύθυνση email*

Να εγγραφώ στο newsletter της Inventor

* Απαραίτητο πεδίο

Αποστέλλοντας τη φόρμα εγγύησης αποδέχεστε τους όρους και τις προϋποθέσεις.

ΑΠΟΣΤΟΛΗ

Στοιχεία μηχανήματος

Τύπος μηχανήματος*

Σειριακός αριθμός εσωτερικού μηχανήματος*

Σειριακός αριθμός εξωτερικού μηχανήματος*

Ημερομηνία αγοράς μηχανήματος*

Αριθμός παραστατικού*

Επιπλέον στοιχεία

- Μόλις ολοκληρωθεί η υποβολή της εγγύησης θα λάβετε την επιβεβαίωση κατοχύρωσης στο email σας

Cuprins

Owner's Manual

0 Precauții privind siguranța04

1 Specificații și caracteristici ale aparatului06

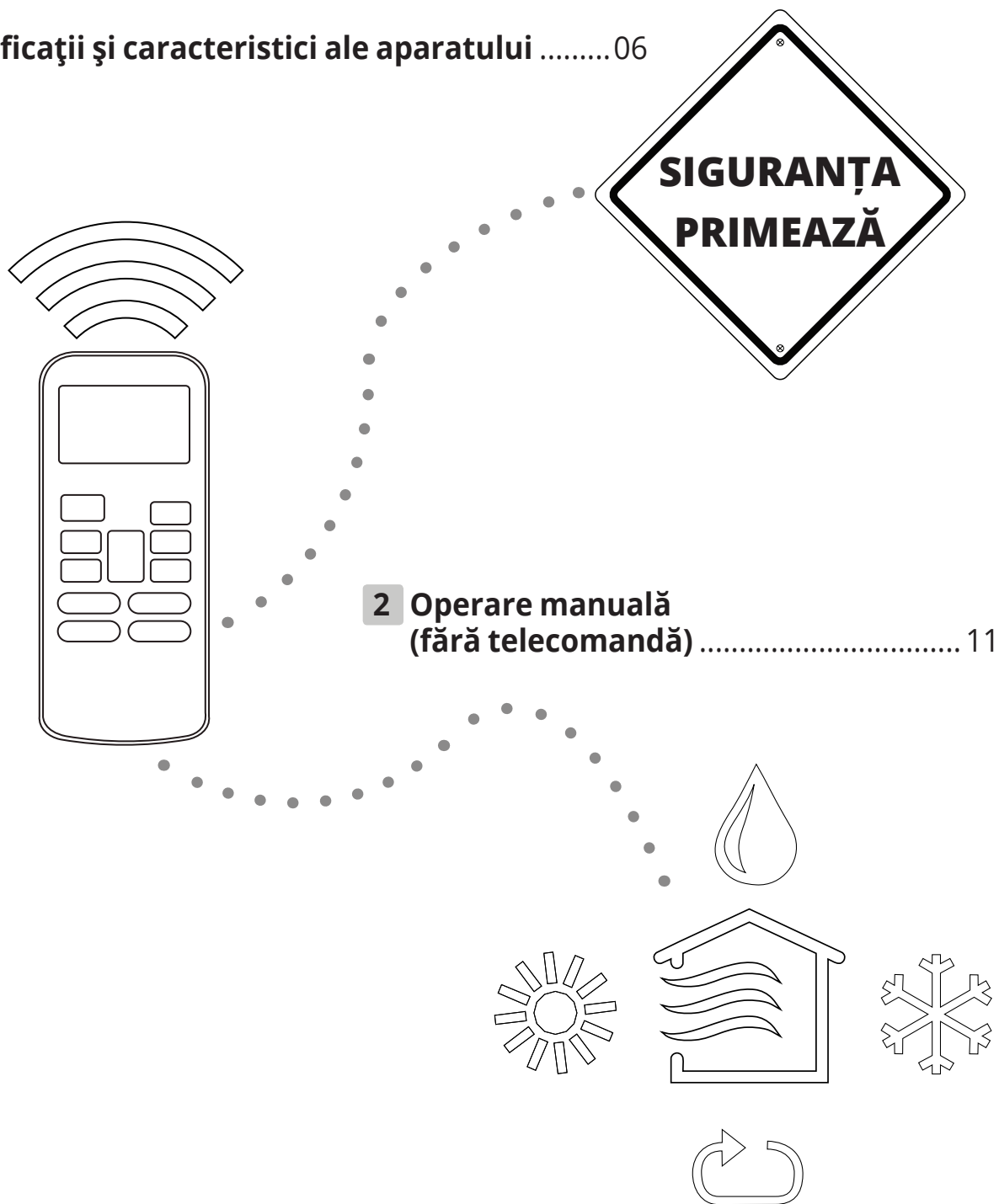

3	Îngrijire și mentenanță	12
4	Rezolvarea problemelor	14
5	Indicații europene pentru eliminare	18

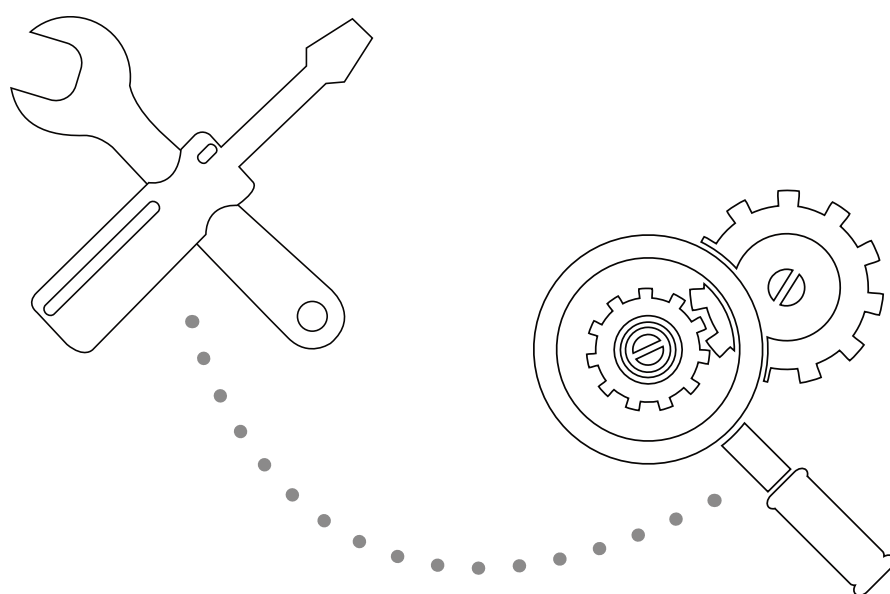

**Atentie: PERICOL DE INCENDIU/
materiale inflamabile**

ATENȚIE: Lucrarile de service vor fi efectuate conform instructiunilor producatorului. Lucrarile de mentenanta si reparatie vor fi efectuate sub supravegherea persoanelor autorizate pentru lucrari cu agenti frigorifici inflamabili. Pentru mai multe informatii, va rugam sa consultati sectiunea :”Informatii cu privire la service” din manualul de instalare.

Precauții privind siguranța

Citiți precauțiile privind siguranța înainte de instalare

Instalarea incorectă datorată ignorării instrucțiunilor poate cauza daune însemnate sau vătămare corporală. Însemnătatea daunelor sau vătămarilor posibile se clasifică fie care AVERTIZARE fie ca ATENȚIONARE.



AVERTIZARE

Acest simbol indică faptul că ignorarea instrucțiunilor poate duce la deces sau vătămare gravă.



ATENȚIONARE

Acest simbol indică faptul că ignorarea instrucțiunilor poate duce la vătămare moderată asupra propriei persoane sau avarierea aparatului sau proprietății dvs.

AVERTIZARE

Acest aparat poate fi utilizat de către copiii de peste 8 ani și de către persoanele cu capacități fizice, senzoriale sau mentale reduse, sau cu lipsă de experiență și cunoștințe dacă sunt supravegheate sau instruite cu privire la utilizarea aparatului în siguranță și dacă înțeleg pericolele asociate cu aceasta. Nu permiteți copiilor să se joace cu aparatul. Curățarea și mentenanța realizată de utilizator nu trebuie realizată de copii fără supraveghere.

AVERTIZĂRI LEGATE DE INSTALARE

- Cereți unui dealer autorizat să instaleze acest aparat de aer condiționat. Instalarea neadecvată poate cauza scurgeri de apă, electrocutare sau incendiu.
- Toate reparațiile, mentenanța și mutarea acestui aparat trebuie realizate de către un tehnician autorizat de service. Reparațiile neadecvate pot duce la vătămări grave sau avarierea produsului.

AVERTIZĂRI LEGATE DE UTILIZAREA PRODUSULUI

- Dacă apare o situație anormală (de genul mirosului de ars), opriți imediat aparatul și trageți din priză. Sunați la dealer pentru instrucțiuni pentru a evita electrocutarea, incendiul sau vătămarea.
- **Nu** introduceți degetele, bețe sau alte obiecte în admisia sau evacuarea de aer. Acest lucru poate cauza vătămare, deoarece ventilatorul se poate roti la viteze mari.
- **Nu** utilizați sprayuri inflamabile de genul fixativului, lacuri sau vopsele în apropierea aparatului. Acest lucru poate duce la incendiu sau explozie.
- **Nu** permiteți funcționarea aparatului de aer condiționat în locuri din apropierea sau din jurul gazelor inflamabile. Gazele emise se pot acumula în jurul aparatului și pot duce la explozie.
- **Nu** permiteți funcționarea aparatului de aer condiționat într-o cameră cu umiditate mare (de exemplu baie sau camera pentru spălat rufe). Acest lucru poate duce la electrocutare și poate cauza deteriorarea produsului.
- **Nu** vă expuneți corpul în mod direct la aerul rece pentru perioade lungi de timp.

AVERTIZĂRI LEGATE DE ELECTRICITATE

- Utilizați doar cablul de alimentare indicat. Dacă acest cablu de alimentare este avariata, el trebuie înlocuit de către producător sau de către un agent de service autorizat.
- Mențineți ștecherul curat. Îndepărtați praful sau murdăria ce se adună pe sau în jurul ștecherului. Ștecherele murdare pot duce la incendiu sau electrocutare.
- **Nu** trageți de cablul de alimentare pentru a scoate din priză aparatul. Apucați ferm de ștecher și scoateți din priză. Trasul direct de cablul de alimentare poate duce la avariarea lui ce poate conduce la incendiu sau electrocutare.
- **Nu** utilizați un prelungitor, nu extindeți manual cablul de alimentare, și nu conectați alte aparate la aceeași priză ca și cea a aparatului de aer condiționat. Legăturile electrice slabe, izolarea proastă și voltaj insuficient pot duce la incendiu.





AVERTIZĂRI LEGATE DE CURĂȚARE ȘI MENTENANȚĂ

- Opriți aparatul și scoateți din priză înainte de a-l curăța. Dacă nu faceți acest lucru vă puteți electrocuta.
- **Nu** curățați aparatul de aer condiționat cu o cantitate mare de apă.
- **Nu** curățați aparatul de aer condiționat cu agenți de curățare inflamabili. Agenții de curățare inflamabili pot duce la incendiu sau deformare.

ATENȚIONĂRI

- Dacă aparatul de aer condiționat este utilizat cu arzătoare sau alte aparate pentru încălzit, aerisiți foarte bine camera pentru a evita lipsa oxigenului.
- Opriți aparatul de aer condiționat și scoateți din priză aparatul dacă nu intenționați să îl utilizați pentru o perioadă lungă de timp.
- Opriți și scoateți din priză aparatul în timpul furtunilor.
- Asigurați-vă că apa rezultată din condens se poate scurge din aparat
- **Nu** manevrați aparatul de aer condiționat cu mâinile ude. Acest lucru poate duce la electrocutare. Nu utilizați aparatul în alte scopuri decât pentru utilizarea specificată.
- **Nu** vă urcați pe sau nu puneți obiecte pe unitatea exterioară.
- **Nu** permiteți aparatului de aer condiționat să funcționeze perioade lungi de timp cu ușile și ferestrele deschise, sau dacă umiditatea este foarte mare.

Explicarea simbolurilor afisate pe unitatile interioare/exteriorare (valabil doar pentru aparatele care folosesc agent frigorific R32/R290):

	AVERTIZARE	Acest simbol va subliniaza faptul ca aparatul utilizeaza agent frigorific inflamabil. In cazul unei scurgeri, poate aparea pericolul declansarii unui incendiu.
	ATENȚIONARE	Acest simbol va atentioneaza ca manualul de utilizare trebuie citit cu atentie.
	ATENȚIONARE	Acest simbol va atentioneaza asupra faptului ca personalul autorizat va trebui sa respecte cu strictete manualul de instalare.
	ATENȚIONARE	
	ATENȚIONARE	Acest simbol va atentioneaza ca informatiile necesare pot fi gasite in manualul de utilizare sau manualul de instalare.

Specificații și caracteristici ale aparatului

1

Componente ale aparatului

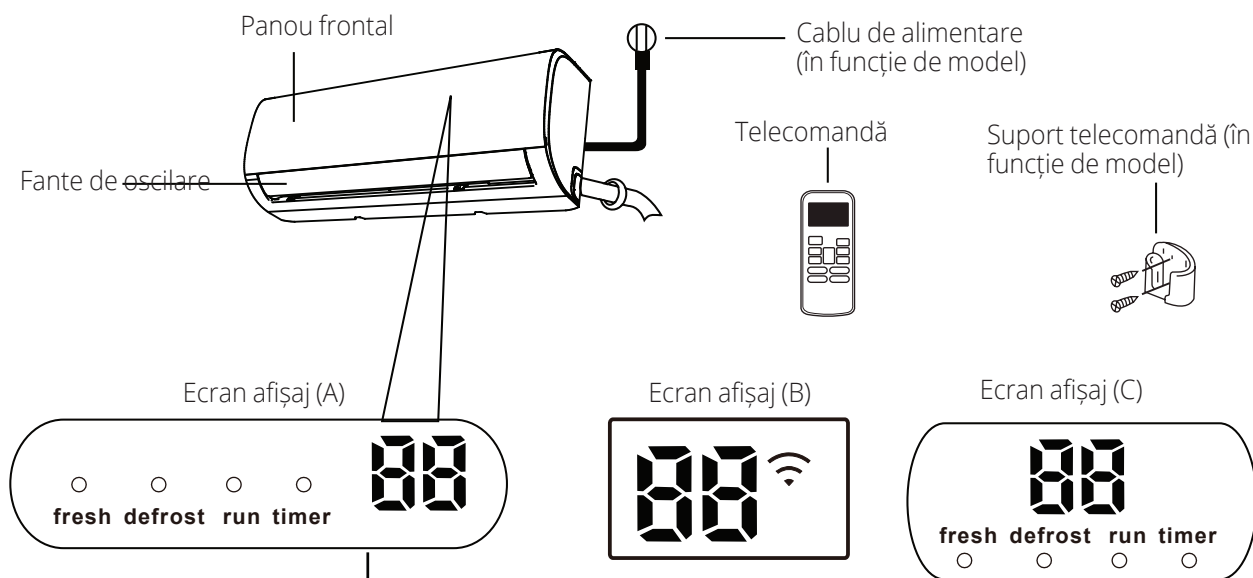

"fresh" atunci când funcția Fresh este activă.

"defrost" la activarea funcției de degivrare.

"run" la pornirea aparatului.

"timer" la activarea temporizatorului.

"88" atunci când este activată funcția ECONOMISIRE, simbolul "88" se aprinde intermitent ca și
E -- C -- 0 -- setare temperatură - E..... En la intervale de o secundă.
În alte module, aparatul va afișa setarea dvs. de temperatură.
În modulul Ventilare, aparatul va afișa temperatura camerei.
La apariția unei erori, codul acesteia va fi afișat.

01 pentru 3 secunde atunci când:

- TEMPORIZATORUL este pornit
- Funcțiile REÎMPROSPĂTARE, OSCILARE; TURBO sau SILENȚIOS sunt activate

0F pentru 3 secunde atunci când:

- TEMPORIZATORUL este oprit
- Funcțiile REÎMPROSPĂTARE, OSCILARE; TURBO sau SILENȚIOS sunt dezactivate

cF atunci când funcția împotriva aerului rece este activată

dF în timpul degivrării

5C atunci când aparatul este pornit pe auto-curățare

FP atunci când este pornită protecția la îngheț

Wi-Fi când funcția de control prin WIFI este activată (în funcție de model)

Semnificație coduri afișate

NOTĂ: Instrucțiuni pentru utilizarea telecomenzii cu infraroșu nu sunt incluse în acest manual

Atingerea Performanței optime

Performanța optimă pentru modulele RĂCIRE, ÎNCĂLZIRE și DEZUMIDIFICARE poate fi atinsă în următoarele intervale de temperatură. Atunci când aparatul de aer condiționat este folosit în afara acestor intervale, anumite funcții de protecție a siguranței se vor activa iar aparatul va funcționa mai puțin eficient.

Invertor de tip split

	Modul RĂCIRE	Modul ÎNCĂLZIRE	Modul DEZUMIDIFICARE
Temperatura camerei	17°C - 32°C (63°F - 90°F)	0°C - 30°C (32°F - 86°F)	10°C - 32°C (50°F - 90°F)
Temperatura din exterior	0°C - 50°C (32°F - 122°F)	-15°C - 30°C (5°F - 86°F)	0°C - 50°C (32°F - 122°F)
	-15°C - 50°C (5°F - 122°F) (Pentru modele cu sisteme de răcire la temp. scăzute)		
	0°C - 60°C (32°F - 140°F) (Pentru modele tropicale speciale)	0°C - 60°C (32°F - 140°F) (Pentru modele tropicale speciale)	

PENTRU APARATE CU ÎNCĂLZIRE ELECTRICĂ SUPLEMENTARĂ

Atunci când temperatura din exterior este mai mică de 0°C (32°F), vă recomandăm insistent să păstrați aparatul în priză mereu pentru a asigura o performanță continuă bună.

Model cu viteza fixa

	Modul RĂCIRE	Modul ÎNCĂLZIRE	Modul DEZUMIDIFICARE
Temperatura camerei	17°-32°C (63°-90°F)	0°-30°C (32°-86°F)	13°-32°C (50°-90°F)
Temperatura din exterior	18°-43°C (64°-109°F)	-7°-24°C (19°-75°F)	18°-43°C (64°-109°F)
	-7°-43°C (19°-109°F) (Pentru modele cu sisteme de răcire la temp. scăzute)		18°-43°C (64°-109°F)
	18°-54°C (64°-129°F) (Pentru modele tropicale speciale)		18°-54°C (64°-129°F) (Pentru modele tropicale speciale)

Pentru a optimiza performanța aparatului dvs., vă rugăm să luați următoarele acțiuni:

- Să țineți ușile și ferestrele închise.
- Să limitați utilizarea energiei electrice prin folosirea funcțiilor de TEMPORIZARE PORNITĂ și TEMPORIZARE OPRITĂ.
- Nu blocați admisia sau evacuarea aerului.
- Verificați regulat și curățați filtrele de aer

Pentru explicații detaliate ale fiecărei funcții, consultați manualul telecomenzii.

Alte funcții

• Repornirea automată

Dacă aparatul este deconectat de la alimentare va reporni automat utilizând setările anterioare de îndată ce alimentarea este restabilă.

• Funcția anti-mucegai

La oprirea aparatului din modulele RĂCIRE, AUTOMAT (RĂCIRE) sau DEZUMIDIFICARE aparatul de aer condiționat va continua să funcționeze în mod economic pentru a usca apa condensată și a preveni apariția mușei.

• Detectarea scurgerilor de agent frigorific

Unitate interioară va afișa automat „EC” atunci când detectează scurgeri de agent frigorific.

• Control Wi-Fi

Controlul Wi-Fi vă permite să controlați aparatul de aer condiționat folosind telefonul mobil și o conexiune Wi-Fi.

Înlocuirea moduluui Wi-Fi sau lucrari de mentenanță la acesta, contactați departamentul de service sau persoane calificate.

• Memorarea unghiului fantei de oscilare

La pornirea aparatului dvs., fanta de oscilare va fi poziționată automat în unghiul folosit anterior.

Pentru explicații detaliate cu privire la funcționarea avansată a aparatului dvs. (cum ar fi modulul TURBO și funcțiile de curățare automată) vă rugăm consultați manualul telecomenzii.

NOTĂ PRIVIND IMAGINILE

Imagine din prezentul manual au scop explicativ. Forma reală a unității dvs. interioare poate fi ușor diferită. Forma reală va fi cea care va prevala.

• Setarea unghiului pentru fuxul de aer

Setarea unghiului orizontal pentru fluxul de aer

Unghiul orizontal al fluxului de aer trebuie setat manual. Apucați tija deflectorului (Fig. 2.3) și potriviți manual direcția conform preferințelor dvs. În funcție de model, unghiul orizontal al fluxului de aer poate fi setat prin telecomandă. Vă rugăm consultați manualul telecomenzii.

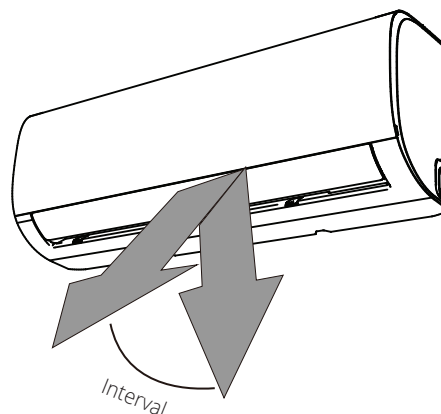

Atenție: nu mențineți fanta de oscilare la un unghi prea vertical pentru perioade lungi de timp. Acest lucru va duce la condensarea apei și picurarea ei pe mobilier.



ATENȚIONARE

Nu introduceți degetele în sau în apropiere de partea de evacuare și admisie a aparatului. Viteza mare a ventilatorului din interior poate duce la vătămare.

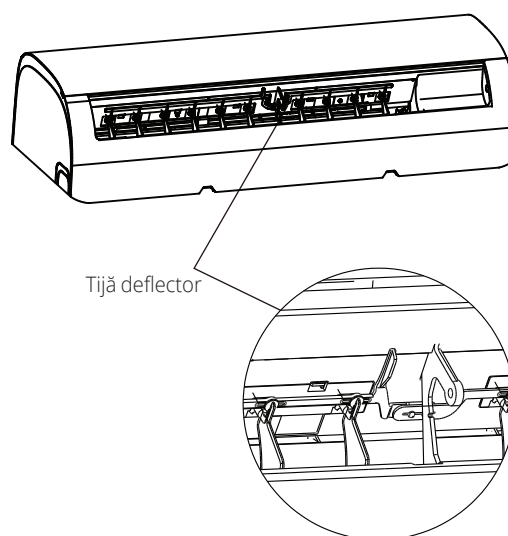

Tijă deflector

• Funcționarea în modul în așteptare

Funcția ÎN AȘTEPTARE este utilizată pentru a scădea consumul de energie în timp ce dormiți (și nu aveți nevoie de aceeași setare de temperatură pentru a vă simți confortabil). Această funcție poate fi activată doar cu ajutorul telecomenzii.

Apăsați butonul ÎN AȘTEPTARE atunci când vă pregătiți de culcare. Când se află în modul RĂCIRE, aparatul va crește temperatura cu 1°C (2° F) după o oră și va crește suplimentar cu câte 1°C (2° F) după fiecare oră. Atunci când se află în modul ÎNCĂLZIRE, aparatul va scădea temperatura cu 1°C (2° F) după o oră și va scădea suplimentar cu câte 1°C (2° F) după fiecare oră.

Acesta va păstra noua temperatură timp de 7 ore, după care aparatul se va opri automat.

Notă: funcția ÎN AȘTEPTARE nu este disponibilă în modulul VENTILARE sau DEZUMIDIFICARE.

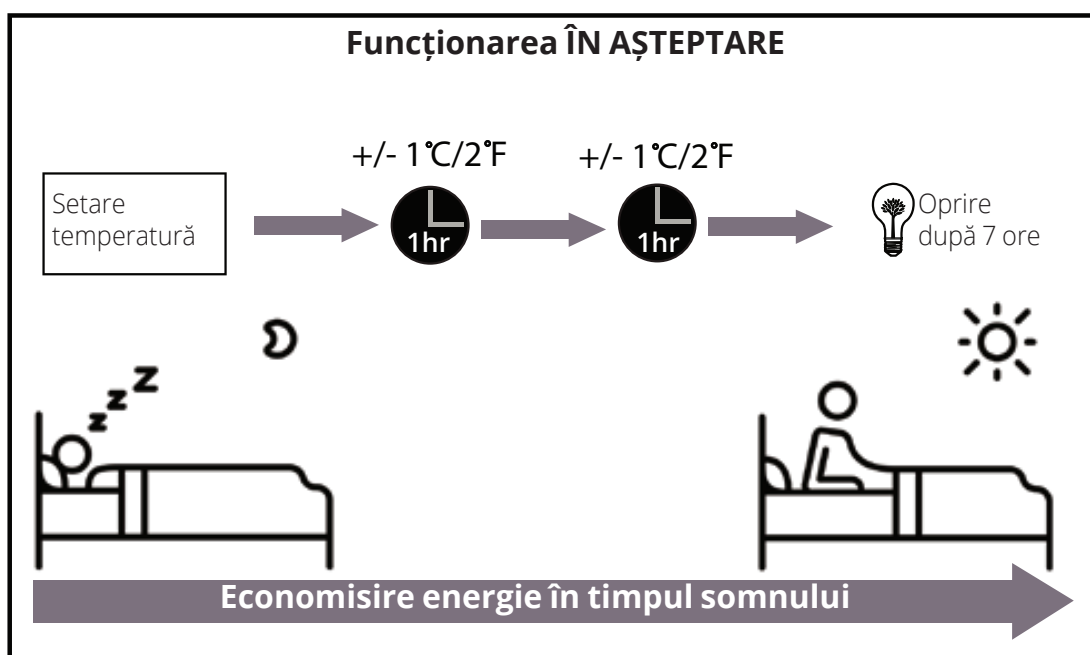

Operarea manuală (fără telecomandă)

2

Cum să operați aparatul dvs. fără telecomandă

În cazul în care telecomanda dvs. nu mai funcționează, aparatul poate fi operat manual cu ajutorul butonului de control manual de pe unitatea interioară. Vă rugăm să luați în considerare că funcționarea manuală nu este o soluție pe termen lung și că funcționarea aparatului cu ajutorul telecomenzii este insistent recomandată.

ÎNAINTE DE OPERAREA MANUALĂ

Aparatul trebuie oprit înainte de operarea manuală

Pentru operarea manuală a aparatului:

1. Deschideți panoul frontal al unității interioare
2. Localizați butonul de CONTROL MANUAL de pe partea dreaptă a unității.
3. Apăsați butonul de CONTROL MANUAL odată pentru a activa modulul AUTOMAT FORȚAT.
4. Apăsați din nou butonul CONTROL MANUAL pentru a activa modulul RĂCIRE FORȚATĂ.
5. Apăsați butonul CONTROL MANUAL a treia oară pentru a opri aparatul.
6. Închideți panoul frontal.

! AVERTIZARE

Butonul manual este destinat scopurilor de testare și funcționării în caz de urgență. Vă rugăm nu folosiți această funcție decât dacă telecomanda este pierdută sau acest lucru este absolut necesar. Pentru a reveni la funcționarea normală, utilizați telecomanda pentru a activa aparatul.

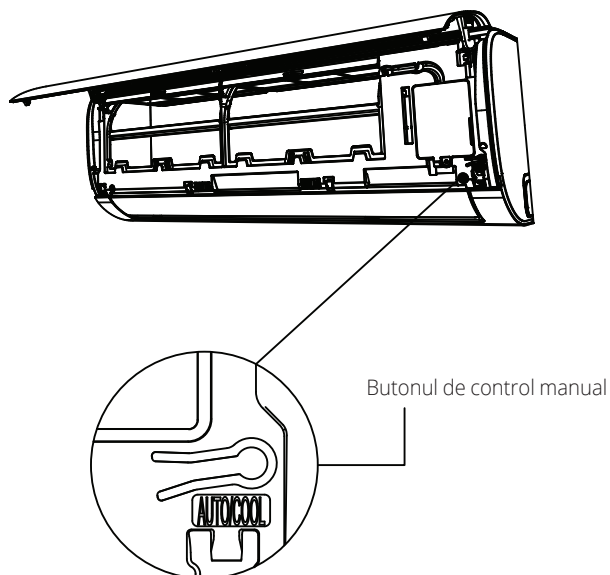

Îngrijire și mentenanță

3

Curățarea unității interioare

! ÎNAINTE DE CURĂȚARE SAU MENTENANȚĂ

OPRIȚI ÎNTOTDEAUNA SISTEMUL DE AER CONDIȚIONAT ȘI SCOATEȚI DIN PRIZĂ ÎNAINTE DE CURĂȚARE SAU MENTENANȚĂ.

! ATENȚIONARE

Utilizați doar o cârpă moale și uscată pentru a șterge aparatul. Dacă aparatul este foarte murdar, puteți folosi o cârpă înmuiată în apă caldă pentru a-l șterge.

- Nu utilizați chimicale și cârpe tratate chimic pentru a curăța aparatul
- Nu utilizați benzen, diluant, praf de curățat sau alți solvenți pentru a curăța aparatul. Acest lucru poate duce la crăparea sau deformarea capacului de plastic.
- Nu folosiți apă mai caldă de 40°C (104°F) pentru a curăța panoul frontal. Acest lucru poate duce la deformarea panoului sau decolorarea acestuia.

Curățarea filtrului de aer

Un aparat de aer condiționat înfundat poate reduce eficiența de răcire a aparatului dvs. și vă poate dăuna sănătății.

Asigurați-vă că filtrul este curățat o dată la două săptămâni.

1. Ridicați panoul frontal al unitatii interioare.
2. Apasati clapeta de la marginea filtrului pentru a slabi catarama, apoi trageți ușor către dvs.
3. Acum puteți scoate filtrul.
4. Dacă filtrul dumneavoastră de aer are disponibil un filtrul pentru îmborspatarea aerului, detasati acel filtru si curatati-l cu ajutorul unui aspirator.
5. Curățați filtrul de aer mare cu apă caldă cu săpun. Este important să folosiți un detergent delicat.

6. Clătiți filtrul cu apă curată apoi scuturați excesul de apă.
7. Uscați-l într-un loc răcoros și uscat și nu îl expuneți în lumina directă a soarelui.
8. După uscare, atașați filtrul pentru îmborspatarea aerului de filtrul de aer și apoi introduceți-le în unitatea interioară.
9. Închideți panoul frontal al unitatii interioare.

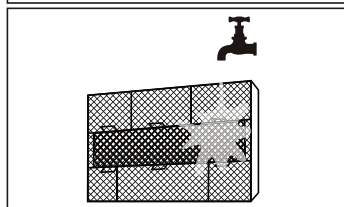
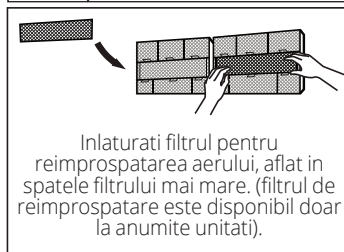
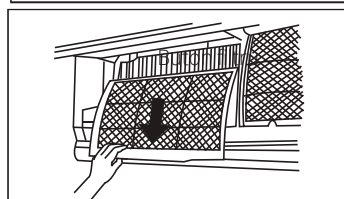
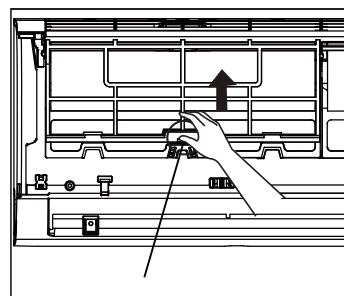

! ATENȚIONARE

Nu atingeți filtrul de îmborspatare aer (plasma) pentru cel puțin 10 minute după oprirea aparatului.

! ATENȚIONARE

- Înainte de a schimba sau curăța filtrul, opriți aparatul și scoateți-l din priză.
- La îndepărtarea filtrului, nu atingeți părțile metalice din aparat. Marginile metalice ascuțite vă pot tăia.
- Nu utilizați apa pentru a curăța interiorul unității interioare. Acest lucru poate distruge izolarea și poate duce la electrocutare.
- Nu expuneți filtrul în lumina directă a soarelui în timpul uscării. Acest lucru poate micșora filtrul.

! ATENȚIONARE

- Orice acțiune de mentenanță sau curățare a unității exterioare va fi efectuată de către un dealer autorizat sau un furnizor de service autorizat.
- Orice reparații ale aparatului trebuie realizate de către un dealer autorizat sau un furnizor de service autorizat.

Mentenanță - Perioade lungi de neutilizare

Dacă plănuți să nu utilizați aparatul de aer condiționat pe o perioadă mai mare de timp, luați următoarele măsuri:

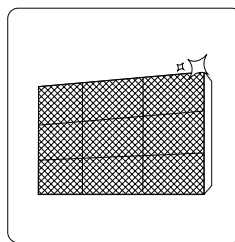

Curățați toate filtrele

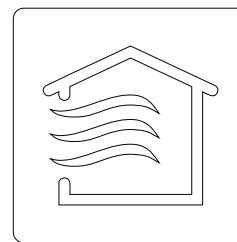

Porniți funcția de ventilare până la uscare completă

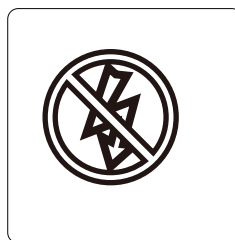

Opriți aparatul și deconectați de la alimentarea electrică

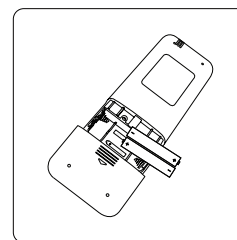

Îndepărtați bateriile din telecomandă

Mentenanță - Inspekția înainte de sezon

Dacă plănuți să nu utilizați aparatul de aer condiționat pe o perioadă mai mare de timp, luați următoarele măsuri:

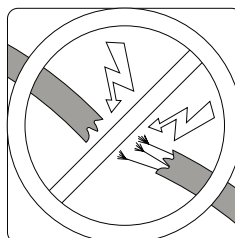

Verificați avarierea firelor

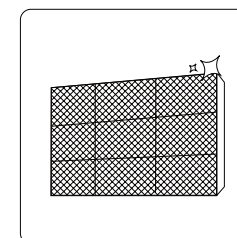

Curățați toate filtrele



Verificați să nu existe scurgeri

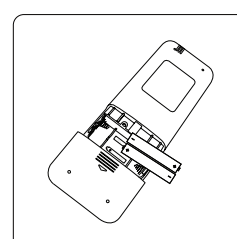

Înlocuiți bateriile

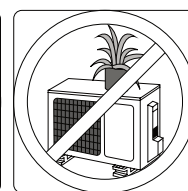
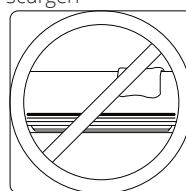

Asigurați-vă că admisia /evacuarea aer nu sunt blocate

Rezolvarea problemelor

4

! PRECAUȚII PRIVIND SIGURANȚA

Dacă apare ORICARE din următoarele condiții, opriți aparatul imediat!

- Cablul de alimentare este avariata sau anormal de cald
- Simțiți un miros de ars
- Unitatea scoate zgomote puternice sau anormale
- Se arde o siguranță sau întrerupătorul se declanșează frecvent
- Apă sau alte obiecte cad în sau pe aparat

NU ÎNCERCAȚI SĂ REZOLVAȚI SINGURI ACESTE PROBLEME, CONTACTAȚI FURNIZORUL DE SERVICE AUTORIZAT IMEDIAT!

Probleme obișnuite

Următoarele probleme nu reprezintă o defecțiune și în majoritatea situațiilor nu necesită reparații.

Problemă	Cauze posibile
Aparatul nu pornește la apăsarea butonului pornire / oprire	Aparatul are o funcție de protecție de 3 minute ce previne supraîncălzirea aparatului. Aparatul nu poate fi repornit în cadrul celor trei minute de la oprire.
Aparatul se schimbă de pe modul RĂCIRE / ÎNCĂLZIRE pe modul VENTILARE	Aparatul își poate schimba setările pentru a preveni acumularea gheții pe aparat. Odată ce temperatura crește, aparatul va funcționa în modul de funcționare selectat anterior.
	Temperatura setată a fost atinsă, moment în care aparatul oprește compresorul. Aparatul va continua funcționarea atunci când temperatura fluctuează din nou.
Unitatea interioară emană o ceață albă	În zonele cu umiditate ridicată, o diferență mare de temperatură între aerul din cameră și aerul condiționat pot duce la formarea de ceață albă.
Atât unitatea interioară cât și cea exterioară emană o ceață albă	Atunci când aparatul care pornește în modulul ÎNCĂLZIRE după degivrare, o ceață albă poate fi emanată datorită umezelii generate de procesul de degivrare.

Problemă	Cauze posibile
Unitatea interioară scoate zgomot	Un zgomot de circulare a aerului poate apărea la resetarea poziției fantei de oscilare.
	Un sunet de scârțâit poate apărea la funcționarea aparatului în modul ÎNCĂLZIRE datorită dilatării și contracției părților din plastic ale aparatului.
Atât unitatea interioară cât și cea exterioară scot zgomote	Un sunet încet șuierat în timpul funcționării: acest lucru este normal și este cauzat de scurgerea gazului frigorific atât prin unitatea interioară cât și prin cea exterioară.
	Sunet încet de șuierat la pornirea sistemului, atunci când funcționarea este oprită sau în timpul degivrării. Acest zgomot este normal și este cauzat de gazul frigorific care se oprește și își schimbă direcția.
	Un sunet de scârțâit: dilatarea și contracția normală a plasticului și a pieselor din metal cauzată de schimbările de temperatură din timpul funcționării pot duce la un zgomot de scârțâit.
Unitate exterioară scoate zgomote	Aparatul va scoate diferite sunete în funcție de modul de funcționare actual.
Iese praf fie din unitatea interioară fie din cea exterioară	Aparatul poate acumula praf pe parcursul perioadelor lungi de neutilizare, praf ce va fi eliminat atunci când aparatul este pornit. Acest lucru poate fi diminuat prin acoperirea aparatului pe timpul perioadelor lungi de inactivitate.
Aparatul emană un miros neplăcut	Aparatul poate absorbi mirosuri din mediul înconjurător (cum ar fi cel de mobilă, de la gătit, de țigări etc.) care va fi emis în timpul funcționării
	Filtrele aparatului au mucegăit și trebuie curățate.
Ventilatorul unității exterioare nu funcționează	În timpul funcționării, viteza ventilatorului este controlată pentru a optimiza funcționarea produsului.
Funcționarea este haotică, imprevizibilă sau aparatul nu răspunde comenzilor	Interferențe de la relee de telefonie mobilă și amplificatoare de la distanță pot duce la funcționarea defectuoasă a aparatului. În acest caz încercați următoarele: <ul style="list-style-type: none"> • Deconectați de la energia electrică apoi reporniți; • Apăsați butonul PORNIRE / OPRIRE de pe telecomandă pentru a restabili funcționarea.

NOTĂ: dacă problema persistă, contactați un dealer local de la cel mai apropiat centru de service pentru clienți. Vă rugăm să le furnizați o descriere detaliată a defecțiunii aparatului cât și numărul modelului dvs.

Rezolvarea problemelor

Atunci când apar probleme, vă rugăm verificați următoarele puncte înainte de a contacta compania pentru reparații.

Problemă	Cauze posibile	Soluție
Performanță slabă de răcire	Setarea temperaturii poate fi mai mare decât temperatura ambientală.	Scădeți setările de temperatură.
	Schimbătorul de căldură de pe unitatea interioară sau exterioară este murdar.	Curățați schimbătorul de căldură afectat.
	Filtrul de aer este murdar.	Înlăturați filtrul și curățați-l conform instrucțiunilor.
	Admisia sau evacuarea de aer a oricărei dintre unități este blocată.	Opriti aparatul, îndepărtați obstrucțiile și porniți-l din nou.
	Ușile sau ferestrele sunt deschise.	Asigurați-vă că toate ușile și ferestrele sunt închise în timpul funcționării aparatului.
	O căldură excesivă este generată de lumina soarelui.	Închideți ferestrele și perdelele în perioadele călduroase sau cele cu lumina puternică a soarelui.
	Există prea multe surse de încălzire în cameră (oameni, computere, electronice, etc.).	Reduceți cantitatea surselor de căldură.
	Agentul frigorific este puțin datorită scurgerilor sau utilizării îndelungate.	Verificați pentru scurgeri, resigilați dacă este necesar și adăugați agent frigorific.
Funcția SILENȚIOS este activată.	Funcția SILENȚIOS poate duce la o performanță scăzută a produsului prin reducerea funcționării frecvente. Opriti funcția SILENȚIOS.	

Problemă	Cauze posibile	Soluție
Aparatul nu funcționează	Cădere de curent	Așteptați revenirea electricității
	Alimentarea este oprită.	Porniți aparatul.
	Siguranța s-a ars.	Înlocuiți siguranța.
	Bateriile telecomenzii sunt terminate.	Înlocuiți bateriile.
	Este activată protecția de 3 minute a aparatului.	Așteptați trei minute după repornirea aparatului.
	Este activat temporizatorul.	Opriți temporizatorul.
Aparatul pornește și se oprește des	Agentul frigorific este prea mult sau prea puțin în sistem.	Verificați scurgerile și reîncărcați sistemul cu agent frigorific.
	Gaze necompresibile sau umezeala au pătruns în sistem.	Eliminați și reîncărcați sistemul cu agent frigorific.
	Compresorul este stricat.	Înlocuiți compresorul
	Voltajul este prea mare sau prea mic.	Instalați un manostat pentru a regla voltajul.
Performanță scăzută de încălzire	Temperatura exterioară este mai mică de 7°C (44.5°F).	Utilizați un dispozitiv de încălzire suplimentar.
	Aerul rece intră pe uși și ferestre.	Asigurați-vă că toate ușile și ferestrele sunt închise în timpul utilizării.
	Agentul frigorific este puțin datorită scurgerilor sau utilizării îndelungate.	Verificați pentru scurgeri, resigilați dacă este necesar și adăugați agent frigorific.
Lumina indicatoare se aprinde intermitent	Aparatul se poate opri din funcțiune sau poate continua să funcționeze în siguranță. Dacă lumina indicatorului continuă să se aprindă intermitent sau apar coduri de eroare, așteptați aproximativ 10 minute. Problema se poate rezolva de la sine. Dacă nu, deconectați de la energia electrică apoi reconectați. Porniți aparatul.	
Apare un cod de eroare pe ecranul de afișaj al unității interioare - E0, E1, E2... - P1, P2, P3... - F1, F2, F3...	Dacă problema persistă, deconectați de la energia electrică și contactați cel mai apropiat centru de service pentru clienți.	

NOTĂ: dacă problema persistă după realizarea verificărilor și diagnostice lor de mai sus, opriți imediat aparatul și contactați un Centru de Service autorizat.

Indicații europene pentru eliminare

5

Acest aparat conține agent frigorific și alte materiale cu potențial periculos. Atunci când eliminați acest aparat, legea prevede o colectare și tratare specială. Nu eliminați acest produs ca și deșeu menajer sau deșeu municipal nesortat.

La eliminarea acestui aparat, aveți la dispoziție următoarele opțiuni:

- Aruncați aparatul în cadrul instalației municipale de colectare a deșeurilor electronice.
- Atunci când achiziționați un nou aparat, comerciantul va prelua vechiul aparat în mod gratuit.
- Producătorul va primi vechiul aparat gratuit.
- Vindeți aparatul către dealeri de fier vechi certificați.

Notificare specială

Aruncarea acestui aparat în pădure sau în alte medii naturale pune în pericol sănătatea dvs. și dăunează mediului înconjurător. Substanțe periculoase se pot scurge în pânza freatică și pot pătrunde în lanțul alimentar.

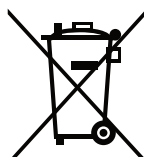

Aspectul unitatii si funciile se pot schimba fara o notificare prealabila, in vederea imbunatatirii produsului. Pentru mai multe informatii, va rugam sa contactati distribuitorul sau producatorul.

Activati-va garantia

- Accesati link-ul de mai jos sau scanati codul QR pentru a va activa garantia pe site-ul nostru.

<https://www.inventoraerconditionat.ro/certificatul-de-garantie-inventor-aer-conditionat-si-electrocasnice>



- Completati toate campurile conform exemplului de mai jos

Pentru a activa garantia, va rugam sa completati urmatoarele campuri

Detalii proprietar

Nume complet*

Adresa*

Cod Postal*

Numar de telefon*

E-mail*

Abonati-va la Newsletter-ul Inventor

* Camp obligatoriu

Cu acest certificat de garantie acceptati Termenii si Conditile.

TRIMITE

Detalii unitate

Tip aparat*

Numărul serial al unității interioare*

Numărul serial al unității exterioare*

Data de achizitie*

Numar Factura*

Detalii aditionale

Odata ce garantia a fost activata, veti primi un email de confirmare



AIR CONDITIONING SYSTEMS

WALL MOUNTED UNIT



Scan here to download the latest version of this manual.
Σαρώστε εδώ για να κατεβάσετε την τελευταία έκδοση του εγχειριδίου.

**Please check the applicable models,
F-GAS and manufacturer information from the "Owner's Manual - Product Fiche"
in the packaging of the outdoor unit. (European Union products only).**

